



 **American
Fluorescent**
by **Hera**[®]



Page Index

	PAGE
Introduction	2
LED	
LED Lighting Information	3
LED-ARF	4
LED-EH24	5
LED-HO	6
LED-STICK	7
LED-TWINSTICK	8
LED-STRIP	9
LED-LINKSTRIP	10
LED-LUMIMAX	11
LED-TOWER	12
LED-FLEX	13
LED-EYE	14
LED-ECO	15
LED-BIG6	16
LED-CAN	17
LED POWER SUPPLY	18
FLUORESCENT SLIMLITE	19
SLIMLITE ACCESSORIES	20
FLUORESCENT SLIMLITE XL	21
SLIMLITE XL ACCESSORIES	22
FLUORESCENT HIGHLITE	23
HIGHLITE ACCESSORIES	24
FLUOROSPOT	25
Xenon	
XR1/XS1	26
Halogen	
KB12/KBS12	27
KBS12 SETS	28
ARF20/ARFS20	29
ARFS20 SETS	30
EH24	31
EH24 SETS	32
ARCLAMP	33
ANTIQUE ARCLAMP	34
ARCTECH	35
WAVE	36
ENTERPRISE	37
TRITECH	38
CBS20	39
ER1/ES1	40
ES1 SETS	41
Transformers	
UC-60FT	42
UE-E60FT	43
UK-120TW/HT-150/HT-300	44
Dimmers	
ETD1 / ETD1-TP	45
ERD1	46
Accessories	
HALOGEN/XENON	47
HALOGEN/XENON	48
Bulbs	49
Product Highlights	50
Installation Options	51
Mounting New Construction Ex.	52
Retrofit Example Power-Top	53
Retrofit Example Power-Below	54
Photometrics	
ARF / EH24 / HO / LUMIMAX	55
TOWER / BIG6 / CAN	56
Technical Information	57
Applications	58
Model No. Index	59

Symbols



Underwriters Laboratories Inc. -
Listing mark for the USA



Underwriters Laboratories Inc.-
Listing mark for Canada



Intertek Testing Services - Listing mark for the USA



Intertek Testing Services - Listing mark Canada



Necessary hole diameter for recessed spotlight



Maximum bulb wattage which can be used
in a particular halogen spotlight



Maximum bulb wattage for MR 11 and MR 16 bulbs
which can be used in a particular halogen spotlight



Beam angle



Minimum clearance to combustible materials in front
of a spotlight



New York City Department of Buildings

American Fluorescent

by **Hera**®

About American Fluorescent: American Fluorescent is a leading manufacturer of lighting fixtures. Family owned, the company has continuously operated since 1937. Headquartered in Waukegan, IL., the company utilizes a national network of sales professionals to pursue residential, light commercial, builder and hospitality markets. To support our customer philosophy, products must meet specific requirements in the areas of design, efficiency (energy savings) and technological advancement. Customers rely on American Fluorescent for a high level of customer satisfaction, superior engineering and contemporary styling.

American Fluorescent has been a strategic partner with Hera, distributing its products since 1995. Hera's product offering meets American Fluorescent's highest design standards, utilizes the latest advancements in technology and offers the most energy efficient lighting products today. Top quality manufacturing and attention to detail, work to keep Hera products at the forefront of today's emerging technologies.

American Fluorescent is nationally recognized for excellence in design and innovation of energy efficient lighting fixtures, winning multiple awards at the "Lighting for Tomorrow" competition the past 5 years. At American Fluorescent, we are committed to offering the best possible solutions for your everyday lighting applications.

About Hera: Hera opened its U.S. headquarters in Atlanta, GA in 1991. We come from a European heritage of innovative lighting design and technology. Hera has been perfecting halogen cabinet lighting since the early 1980's. We were one of the first U.S. companies to introduce halogen cabinet lighting.

All Hera lighting products are unique, stylishly designed and on the leading-edge of today's lighting technology. From our halogen spotlights to SlimLite and our brand new LED line, all of our lighting systems exemplify beauty as well as form and function.

At Hera, we're working hard to continue to produce maximum quality lighting systems. All of our products meet and exceed U.S. safety standards and are UL and/or ETL listed. So, for state-of-the-art lighting systems and accessories that add the perfect accent to any home or business, look no further than Hera. Hera is light years ahead.



LED-Lighting



The Latest Lighting Technology For Your Furniture, Cabinets And Displays

An LED (Light Emitting Diode) is a semiconductor that emits visible light when an electric current passes through. This new lighting technology offers a lot of benefits for the user:

Extremely Long Lifetime: Hera uses only high quality LEDs with a usable lifetime of at least 50,000 hrs. At this point the LEDs still have 70% of their original light output. Unlike incandescent bulbs which burn out abruptly LEDs fail by dimming over time. This extremely long lifetime basically eliminates bulb changes; your savings are obvious.

Lower Power Consumption: LEDs require very little energy compared to incandescent or halogen bulbs resulting in significantly lower energy costs for the user.

High Efficiency: Hera only uses the latest generation of high power LEDs from reputable suppliers such as Luxeon, CREE or Osram. These LEDs are highly efficient and offer a light output of up to 60 IM. W. In comparison the efficiency of halogen bulbs is approximately 22 IM/W. Not only does this high efficiency save you energy costs but it also helps protecting the environment.

Virtually No Heat: Since most of the power to an LED is converted into light, minimal heat is produced. LEDs stay cool to the touch which makes them a very safe light source in retail environments (customers can't burn their fingers). They are also ideal for illuminating heat sensitive products such as chocolate or cosmetics.

No Infrared Or Ultraviolet Radiation: You can illuminate your most sensitive products or collectables without any risk of fading or damage from the light.

LEDs are shatter proof: LEDs are built inside solid cases that protect them, making them virtually impossible to break and very durable. Maintenance is a thing of the past.

These benefits, along with extremely compact dimensions, make LEDs a designer's dream.

Hera has been at the forefront of this new technology. Today we proudly offer you a complete line of LED solutions for unlimited applications. Our engineers will continue to develop innovative products incorporating the advantages LEDs have to offer.

LED-ARF Series



Low-Profile Recessed Or Surface Mounted LED Spotlight

This friction fit spotlight is designed for installation in kitchen cabinets, displays and furniture. It uses the latest generation Power LEDs which offer, in their cool white version, an equivalent light output to a 20W halogen spotlight at only a fraction of the energy consumption (3 W). Virtually no heat emission and no ultraviolet radiation guarantee that your products won't be damaged. 50,000 hrs. of usable life make lamp changes a thing of the past.

Product-Features

- Recess depth only 5/8" or 1/2" (with spacer ring DR13)
- When surface mounted, overall height 7/8"
- Friction fit
- Only 3 Watt power consumption (3 x 1 Watt LEDs)
- Available with cool white (5,500 K) or warm white (3,200 K) LEDs
- Finishes: White, black, chrome, stainless steel and gold
- Attached 69" connecting cable with plug-in connector
- To be used with 350 mA constant current DC converter (PSLED/A)
- Additional accessories available. See page 47

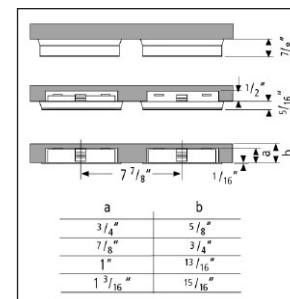
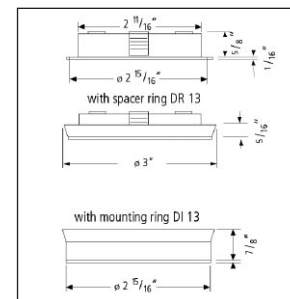

MODEL NO		COLOR	LAMPS		DIMENSIONS	
WARM WHITE	COOL WHITE		QTY	LED	D	DIA
ARFLED3200BL	ARFLED5500BL	BLACK	3	1W LED	5/8"	2-15/16"
ARFLED3200WH	ARFLED5500WH	WHITE	3	1W LED	5/8"	2-15/16"
ARFLED3200SS	ARFLED5500SS	STAINLESS	3	1W LED	5/8"	2-15/16"
ARFLED3200CH	ARFLED5500CH	CHROME	3	1W LED	5/8"	2-15/16"
ARFLED3200GO	ARFLED5500GO	GOLD	3	1W LED	5/8"	2-15/16"
ACCESSORIES	DESCRIPTION					
LEDCC36	CONNECTING CABLE 36"					
LEDCC72	CONNECTING CABLE 72"					
POWER SUPPLY						
PSLED/A	9 X 1 W HIGH POWER LEDs, 350 mA CONSTANT CURRENT DC CONVERTER					

See page 55 for photometric chart

LED-EH24 Series



Recessed Swivel LED Spotlight

Ideally suited for installation inside displays, showcases or cabinets. The swivel feature allows you to direct the light in order to perfectly illuminate merchandise or collectibles. The EH24LED uses the latest generation Power LEDs which offer, in their cool white version, an equivalent light output to a 20 W halogen spotlight at only a fraction of the energy consumption (3 W). Virtually no heat emission and no ultra-violet radiation guarantee that your products won't be damaged. 50,000 hrs. of usable life make lamp changes a thing of the past.

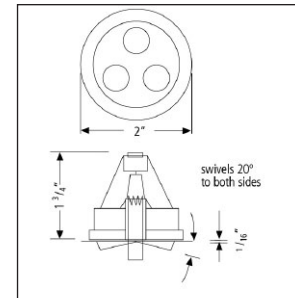

Product-Features

- +/- 20 degree swivel
- Recess depth only 1-3/4"
- Only 3 Watt power consumption (3x1 Watt LEDs)
- Available with cool white (5,500 K) or warm white (3,200 K) LEDs
- Metal housing available in: white, black, chrome, gold and stainless steel
- Attached 69" connecting cable with plug-in connector
- To be used with 350 mA constant current DC converter (PSLED/A)

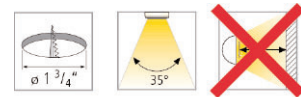

MODEL NO		COLOR	LAMPS		DIMENSIONS	
WARM WHITE	COOL WHITE		QTY	LED	D	DIA
EH24LED3200BL	EH24LED5500BL	BLACK	3	1W LED	1-3/4"	2"
EH24LED3200WH	EH24LED5500WH	WHITE	3	1W LED	1-3/4"	2"
EH24LED3200SS	EH24LED5500SS	STAINLESS	3	1W LED	1-3/4"	2"
EH24LED3200CH	EH24LED5500CH	CHROME	3	1W LED	1-3/4"	2"
EH24LED3200GO	EH24LED5500GO	GOLD	3	1W LED	1-3/4"	2"
ACCESSORIES		DESCRIPTION				
LEDCC36		CONNECTING CABLE 36"				
LEDCC72		CONNECTING CABLE 72"				
POWER SUPPLY						
PSLED/A		9 X 1 W HIGH POWER LEDS, 350 mA CONSTANT CURRENT DC CONVERTER				

See page 55 for photometric chart

LED-HO Series



High Output Swivel And Non-Swivel LED Spotlights

Swivel and non-swivel HO-LED Spots are ideal for applications where high levels of LED light are desired and minimal installation dimensions are not so important. The spotlights feature integrated 3 x 1 W high power LEDs with full LED optics. HO-LED Spots are perfect for displays, larger showcases and even soffits.

Product-Features

- High quality, brushed aluminum housing
- Swivel (+/-20 degrees) and non-swivel version available
- 3 x 1W high power LEDs with full LED optics
- Available with cool white (5,500 K) or warm white (3,200 K) LEDs
- Recess depth 1-1/8" non-swivel, 1-1/16" swivel
- Friction fit
- Attached 79" connecting cable with plug-in connector
- To be used with 350 mA constant current DC converter (PSLED/A)

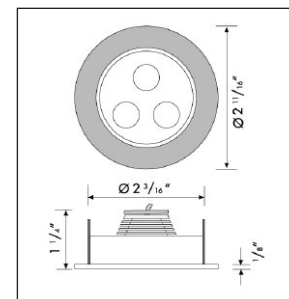

HO-LED 1

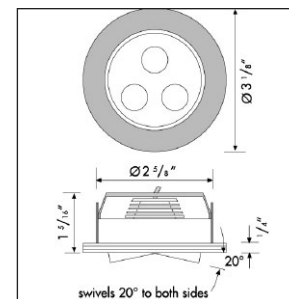

HO-LED 2

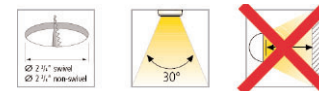

MODEL NO	COLOR	LAMPS	DIMENSIONS		
WARM WHITE	COOL WHITE	QTY	LED	D	DIA
HO-LED1/WW	HO-LED1	3	1W LED	1-1/4"	2-11/16"
HO-LED2/WW (SWIVEL)	HO-LED2 (SWIVEL)	3	1W LED	1-5/16"	3-1/8"
ACCESSORIES	DESCRIPTION				
LEDCC36	CONNECTING CABLE 36"				
LEDCC72	CONNECTING CABLE 72"				
POWER SUPPLY					
PSLED/A	9 X 1 W HIGH POWER LEDS, 350 mA CONSTANT CURRENT DC CONVERTER				

See page 55 for photometric chart

LED-Stick Series



Miniature Linear LED Lighting With Integrated Connecting System

Stick-LED is Hera's latest linear LED lighting solution. These ultra-compact strips of LED lighting feature a very high and even light output and an integrated connecting system. Up to 8' of Stick-LEDs can be connected per run. Stick-LEDs are perfect for furniture, cabinets and displays. They are also the ideal lighting solution for cooler and freezer cases.

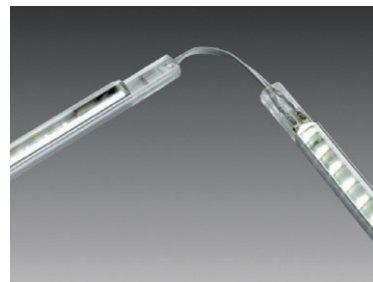

Product-Features

- Aluminum and plexiglass housing
- Extremely small dimensions: width: 3/8", height: 5/16"
- Light fixture can be recessed (flush with board) or surface mounted
- Available in two different sizes: 8" (1.6 W) and 12" (2.4 W)
- Available with cool white (6,400K) and warm white (3,400 K) LEDs
- Extremely high, even light output
- 30,000 hours useable life
- Up to 8' of Stick-LEDs can be connected per run
- Connecting LED cables are available in 1-3/16" and 39" lengths
- Power supply cable 98" to be ordered separately
- To be used with 24V DC LED driver (STICKPS24/30)

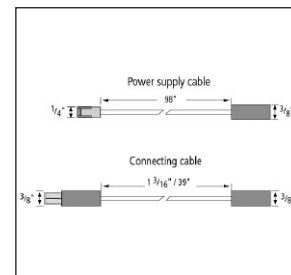
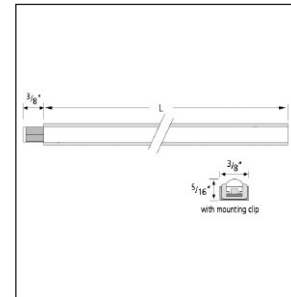

MODEL NO		LAMPS	DIMENSIONS		
WARM WHITE	COOL WHITE	LED	L	W	H
STICKLED8/WW	STICKLED8/CW	1.6 W (TOTAL)	8"	3/8"	5/16"
STICKLED12/WW	STICKLED12/CW	2.4 W (TOTAL)	12"	3/8"	5/16"
ACCESSORY	DESCRIPTION				
STICKPC	POWER CORD		98"		
STICKCC1	CONNECTING CABLE		1-3/16"		
STICKCC39	CONNECTING CABLE		39"		
POWER SUPPLY					
STICKPS24/30	24V/30W DRIVER				

LED-TwinStick Series

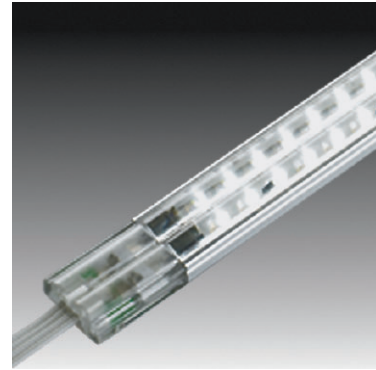

Extremely Compact Linear LED Lighting With Integrated Connecting System

TwinStick-LED is the latest linear LED lighting solution. With an extremely high light output, similar to T5 fluorescent light fixtures, these compact strips are ideal for commercial applications such as store fixtures or displays. Low energy consumption and virtually no maintenance are additional benefits. TwinStick-LEDs feature an integrated connecting system. Up to 8' of TwinStick-LEDs can be connected per run.

Product-Features

- Aluminum and plexiglass housing
- Extremely small dimensions: width: 11/16", height: 5/16"
- Light fixture can be recessed (flush with board) or surface mounted
- Available in two different sizes: 8" (3.0 W) and 12" (4.4 W)
- Available with cool white (6,400 K) and warm white (3,400 K) LEDs
- Extremely high, even light output
- 30,000 hours useable life
- Up to 8' of Twinstick-LEDs can be connected per run
- Connecting LED cables are available in 1-3/16" and 39" lengths
- Power supply cable 98" to be ordered separately
- To be used with 24V DC LED driver (STICKPS24/30)

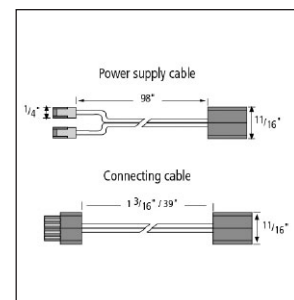
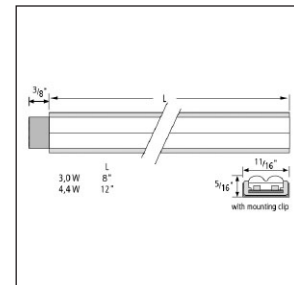

MODEL NO		LAMPS	DIMENSIONS		
WARM WHITE	COOL WHITE	LED	L	W	H
TWINSTICKLED8/WW	TWINSTICKLED8/CW	3.0W (TOTAL)	8"	11/16"	5/16"
TWINSTICKLED12/WW	TWINSTICKLED12/CW	4.4W (TOTAL)	12"	11/16"	5/16"
ACCESSORIES	DESCRIPTION				
TWINSTICKPC	POWER CORD		98"		
TWINSTICKCC1	CONNECTING CABLE		1-3/16"		
TWINSTICKCC39	CONNECTING CABLE		39"		
POWER SUPPLY	24V/30W DRIVER				
STICKPS24/30					

LED-Strip Series



Linear LED Lighting With Optional Corner Extrusion

Strip-LED is perfect for installation in showcases, displays or furniture. The Strip-LED comes in three different sizes (1', 2', 3') and can be recessed or surface mounted. The optional corner extrusion makes this the perfect lighting solution for showcases. Virtually no heat emission, no ultraviolet radiation, low energy consumption, a high and even light output and a long useable LED lifetime (50,000 hrs.) are some of the main benefits of Strip-LED.

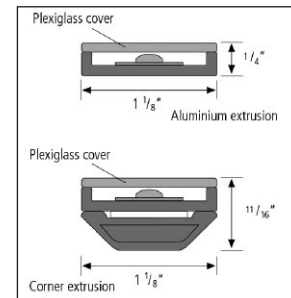

Product-Features

- Anodized aluminum housing with plexiglass cover
- Extremely small dimensions: width: 1-1/8", height: 1/4"
- Available in three different sizes: 11-7/8" (3 x 1 W LED), 23-5/8" (6 x 1 W LED), 35-7/16" (9 x 1 W LED)
- Available with cool white (5,500 K) or warm white (3,200 K) LEDs
- Ready to connect to 350 mA constant current DC converter (PSLED/A)
- Attached 69" connecting cable with plug-in connector
- High, even light output
- Optional aluminum corner extrusion available

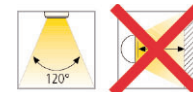
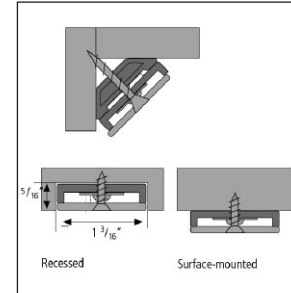

MODEL NO		COLOR	LAMPS		DIMENSIONS		
WARM WHITE	COOL WHITE		QTY	LED	L	W	H
LEDSTRIPWW/1	LEDSTRIP/1	WHITE	3	1W LED	11-7/8"	1-1/8"	1/4"
LEDSTRIPWW/2	LEDSTRIP/2	WHITE	6	1W LED	23-5/8"	1-1/8"	1/4"
LEDSTRIPWW/3	LEDSTRIP/3	WHITE	9	1W LED	35-7/16"	1-1/8"	1/4"
ACCESSORIES		DESCRIPTION					
LEDSTRIP/EXT1	CORNER EXTRUSION						
LEDSTRIP/EXT2	CORNER EXTRUSION						
LEDSTRIP/EXT3	CORNER EXTRUSION						
POWER SUPPLY							
PSLED/A		9 X 1 W HIGH POWER LEDs, 350 mA CONSTANT CURRENT DC CONVERTER					

LED-LinkStrip Series

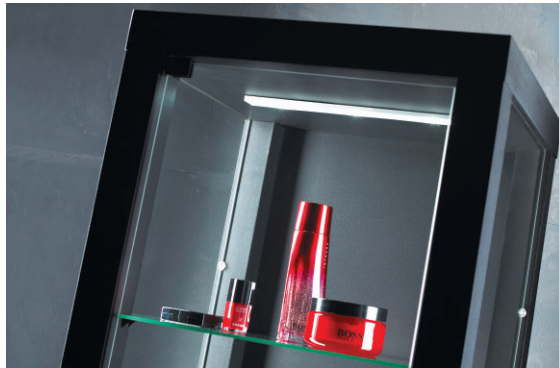

Linear LED Lighting With Integrated Connecting System

LinkStrip-LED is the ideal lighting solution for showcases, displays or under cabinets. It uses the latest generation 1 W high output diodes. The integrated connecting system makes it simple to create continuous lines of LED lighting. The 12" long LED strips can be connected either directly, or, using the optional connecting cables, spaced apart. Up to three LinkStrip-LEDs can be connected to one power supply.

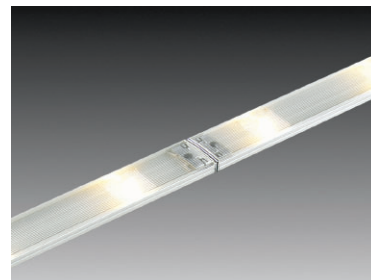

Product-Features

- Anodized aluminum housing with plexiglass cover
- Extremely small dimensions: length: 12", width: 1-1/8", height: "
- High, even light output
- Integrated connecting system
- Ready to connect to 350 mA constant current power supply
- Available with cool white (5,500 K) or warm white (3,200 K) LEDs
- Optional connecting cables available in 6", 12" and 36" lengths
- To be used with 350 mA constant current DC converter (PSLED/A)

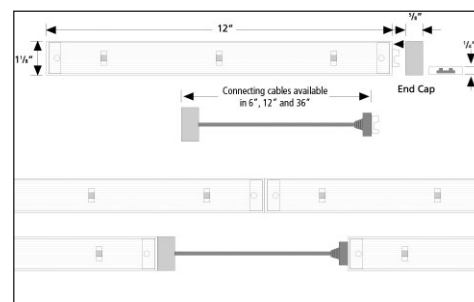

MODEL NO	COLOR	LAMPS	DIMENSIONS				
WARM WHITE	COOL WHITE	QTY	LED	L	W	H	
LINKSTRIPLEDD/WW	LINKSTRIPLEDD/CW	WHITE	3	1W LED	12"	1-1/8"	1/4"
ACCESSORIES	DESCRIPTION						
LINKSTRIPCC/6	CONNECTING CABLE			6"			
LINKSTRIPCC/12	CONNECTING CABLE			12"			
LINKSTRIPCC/36	CONNECTING CABLE			36"			
POWER SUPPLY							
PSLED/A	9 X 1 W HIGH POWER LEDS, 350 mA CONSTANT CURRENT DC CONVERTER						

LED-LumiMax Series



High Output Linear LED Lighting with 3 W Diodes

LumiMax-LED uses the latest 3 W high output diodes which provide an extremely high and even light output. This linear LED light fixture is available in three different lengths and perfect for installations in showcases, displays or under cabinets.

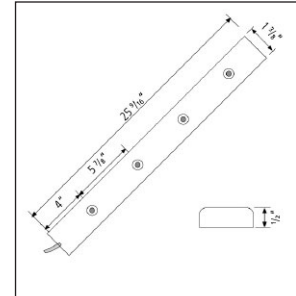

Product-Features

- Very attractive frosted plexiglass housing
- Light fixture can be recessed (flush with board) or surface mounted
- Available with cool white (5,500 K) and warm white (3,200 K) LEDs
- Extremely small dimensions: width: 1-7/16", height: 1/2"
- Available in three different sizes: 13-3/4" (2 x 3 W LED), 25-1/2" (4 x 3 W LED), 37-7/16" (6 x 3 W LED)
- Extremely high, even light output
- Comes complete with (1) constant current DC converter per strip

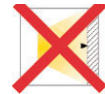
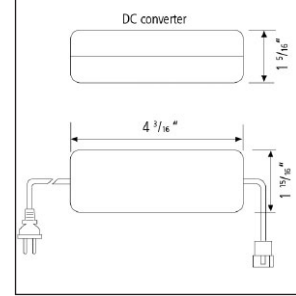

MODEL NO		COLOR	LAMPS		DIMENSIONS		
WARM WHITE	COOL WHITE		QTY	LED	L	W	H
LUMIMAX13/WW	LUMIMAX13	WHITE	2	3W LED	13-3/4"	1-7/16"	1/2"
LUMIMAX25/WW	LUMIMAX25	WHITE	4	3W LED	25-1/2"	1-7/16"	1/2"
LUMIMAX37/WW	LUMIMAX37	WHITE	6	3W LED	37-7/16"	1-7/16"	1/2"
POWER SUPPLY							
INCLUDED							

See page 55 for photometric chart

LED-Tower Series



High Output Display Case LED Lighting With 3 W Diodes

Tower-LED is the ideal lighting solution for display cases. Featuring the latest generation 3 W high output LED diodes, Tower-LED provides an extremely high and even light output. The light fixture swivels 125° and is particularly suitable for installation in jewelry cases, bringing out the sparkle in your diamonds.

Product-Features

- High quality, brushed aluminum and plexiglass housing
- 3 x 3 W high power LEDs
- Available with cool white (5,500 K) or warm white (3,200 K) LEDs
- Height: 8-1/2" , diameter: 1-1/4"
- Swivels 125°
- Very easy installation
- Attached 79" connecting cable with plug-in connector
- Comes complete with (1) constant current DC converter per tower

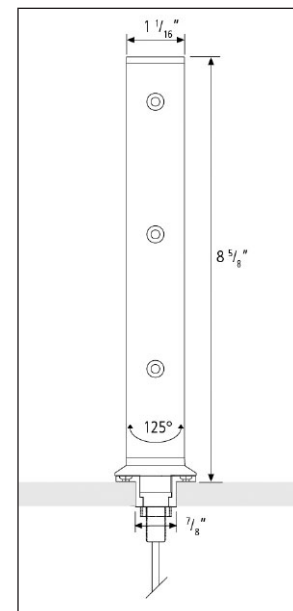

MODEL NO	COLOR	LAMPS	DIMENSIONS			
WARM WHITE	COOL WHITE	QTY	LED	H	DIA	
TOWER-LED/WW	TOWER-LED/CW	3	3W LED	8-1/2"	1-1/16"	
POWER SUPPLY						
INCLUDED						

See page 56 for photometric chart

LED-Flex Series



Flexarm LED Spotlight

Ideal for display application or as a reading light in headboards. The flexible arm allows an exact direction of the light. The 1W high power LED provides good light output without any heat or UV radiation, allowing you to directly illuminate even the most sensitive products.



Flex-LED Atlantis



Flex-LED Edenroc



Flex-LED Side Mount

Product-Features

- 20" long Flexarm
- 1 W high-power LED
- Ready to connect to 350 mA constant current power supply (PSLED/A)
- Attached 51" connecting cable with plug-in connector
- Finish: brushed aluminum
- Available with cool white (5,500K) or warm white (3,200K) LED
- Special order colors and sizes are available for minimum quantities
- Four different versions
- Additional LED connecting cables are available in 36" and 72"

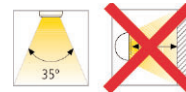
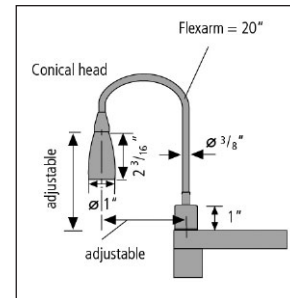

MODEL NO		COLOR	LAMPS		DIMENSIONS	
WARM WHITE	COOL WHITE		QTY	LED	L	D
FLEXLED/WW/MCH	FLEXLED/CW/MCH	BRUSHED ALUMINUM	1	1W LED	22-3/16"	1"
ATLANTIS/WW/MCH	ATLANTIS/CW/MCH	BRUSHED ALUMINUM	1	1W LED	22-3/16"	1"
EDENROC/WW/MCH	EDENROC/CW/MCH	BRUSHED ALUMINUM	1	1W LED	22-3/16"	1"
SIDE/L/WW	SIDE/L/CW	BRUSHED ALUMINUM	1	1W LED	22-3/16"	1"
SIDE/R/WW	SIDE/R/CW	BRUSHED ALUMINUM	1	1W LED	22-3/16"	1"
SIDE/L/S/WW	SIDE/L/S/CW	BRUSHED ALUMINUM	1	1W LED	22-3/16"	1"
SIDE/R/S/WW	SIDE/R/S/CW	BRUSHED ALUMINUM	1	1W LED	22-3/16"	1"
ACCESSORIES	DESCRIPTION					
LEDCC36	CONNECTING CABLE				36"	
LEDCC72	CONNECTING CABLE				72"	
POWER SUPPLY						
PSLED/A	9 X 1 W HIGH POWER LEDS, 350 mA CONSTANT CURRENT DC CONVERTER					
PSLED/A/LINE	9 X 1 W HIGH POWER LEDS - SWITCH COMPATIBLE					

LED-Eye Series



Miniature LED Spotlight

Eye-LED is the perfect lighting solution for all applications where minimal installation dimensions are essential. It fits into a 1" diameter x 1/2" depth installation opening. Eye-LED features a 1 W high power LED.

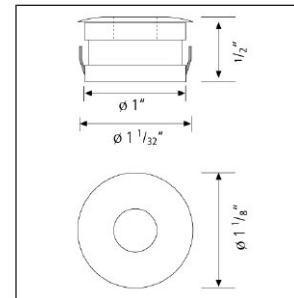

Product-Features

- Extremely small dimensions: recess depth 1/2", recess diameter 1"
- 1 W high-power LED
- Ready to connect to 350 mA constant current power supply (PSLED/A)
- Attached 51" connecting cable with plug-in connector
- Available with cool white (5,500 K) or warm white (3,200 K) LED
- Finish: stainless steel and brushed aluminum
- Additional LED connecting cables are available in 36" and 72"

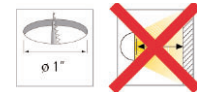
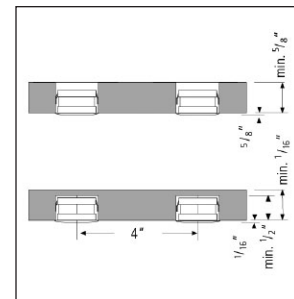

MODEL NO		COLOR	LAMPS		DIMENSIONS	
WARM WHITE	COOL WHITE		QTY	LED	D	DIA
EYELEDSS/WW	EYELEDSS/CW	STAINLESS	1	1W LED	1/2"	1-1/8"
EYELEDA/WW	EYELEDA/CW	ALUMINUM	1	1W LED	1/2"	1-1/8"
ACCESSORIES		DESCRIPTION				
LEDCC36	CONNECTING CABLE		36"			
LEDCC72	CONNECTING CABLE		72"			
POWER SUPPLY						
PSLED/A	9 X 1 W HIGH POWER LEDS, 350 mA CONSTANT CURRENT DC CONVERTER					

LED-Eco Series



Economically Recessed Or Surface Mounted LED Spotlight

Eco-LED is Hera's latest economically priced LED solution. The spotlights feature 1 W high power LEDs with a useable lifetime of 50,000 hrs. and high light output. Eco-LED is ideal for undercabinet, furniture or display applications.

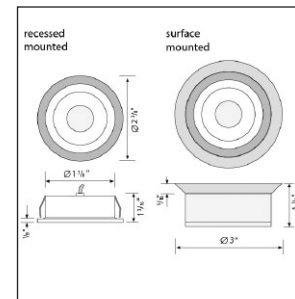

Product-Features

- Recess depth 1-3/16", surface mount height 1-1/4"
- Only 1 Watt power consumption
- Available with cool white (5,500 K) or warm white (3,200 K) LEDs
- Housing available in white, black and stainless steel
- Attached 79" long connecting cable with plug-in connector
- Spotlights come in sets of three, complete with 350 mA constant current DC converter
- Replacement / extra power supplies available
- Additional LED connecting cables are available in 20", 39" and 79"

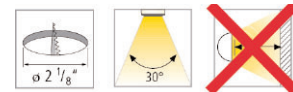
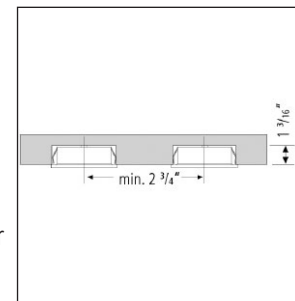

MODEL NO		COLOR	LAMPS		DIMENSIONS	
WARM WHITE	COOL WHITE		QTY	LED	D	DIA
SET2LEDSS/WW	SET2LEDSS/CW	STAINLESS	1	1W LED	1-3/16"	2-3/8"
SET2LEDWH/WW	SET2LEDWH/CW	WHITE	1	1W LED	1-3/16"	2-3/8"
SET2LEDBL/WW	SET2LEDBL/CW	BLACK	1	1W LED	1-3/16"	2-3/8"
ACCESSORIES	DESCRIPTION					
MINI/500	CONNECTING CABLE					
MINI/1000	CONNECTING CABLE					
MINI/1800	CONNECTING CABLE					
POWER SUPPLY	INCLUDED					

LED-Big6 Series



Recessed Swivel LED Spotlight With 6 x 1 W High Power LEDs

The Big6 was especially developed for applications where extremely high levels of light are necessary or desired. The integrated 6 x 1 W high power LEDs provide an extremely high light output. The Big6 is perfect for larger display cases and even for installation in soffits.

Product-Features

- +/- 10 degree swivel
- Recess depth 2-3/16"
- 6 x 1 W high power LEDs
- Available with cool white (5,500 K) or warm white (3,200 K) LEDs
- Housing available in white and stainless steel
- 36" long connector between spotlight and power supply
- Comes complete with 350 mA constant current DC converter

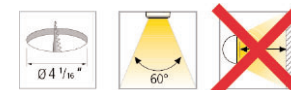
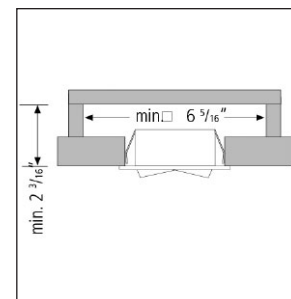
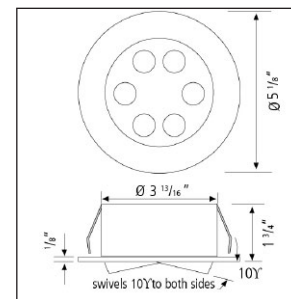

MODEL NO		COLOR	LAMPS		DIMENSIONS	
WARM WHITE	COOL WHITE		QTY	LED	D	DIA
BIG6SS/WW	BIG6SS/CW	STAINLESS	6	1W LED	1-3/4"	5-1/8"
BIG6WH/WW	BIG6WH/CW	WHITE	6	1W LED	1-3/4"	5-1/8"
POWER SUPPLY						
INCLUDED						

See page 56 for photometric chart

LED-Can Series



LED Spotlights For Ceiling Applications

Hera's Can-LEDs are listed according to UL1598 for installation in ceilings. Can-LEDs feature a very compact ceiling can with integrated LED driver. The compact can dimensions make the spotlights suitable for new construction or remodeling. The 6 x 1 W high power LEDs provide a high light output (similar to a 50 W MR16 lamp), perfect for both, residential and commercial applications.



Product-Features

- Two attractive designs available, Can-LED SWIVEL (+/- 10 degree swivel) and Can-LED PLEXI with attractive, frosted plexiglas collar
- 6x1 W high power LEDs
- Recess depth 4-7/8"
- Available with cool white (5,500 K) and warm white (3,200 K) LEDs
- Integrated 350 mA constant current DC converter
- Available in white and stainless steel (swivel version only)

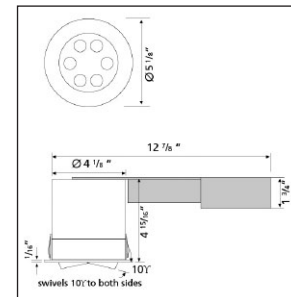

CAN-LED swivel

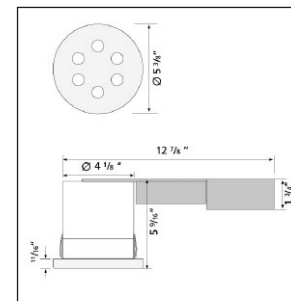

CAN-LED plexi

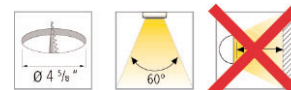

MODEL NO		COLOR	LAMPS		DIMENSIONS	
WARM WHITE	COOL WHITE		QTY	LED	D	DIA
LEDCAN6/SS/WW	LEDCAN6/SS/CW	STAINLESS	6	1W LED	5"	5-1/8"
LEDCAN6/WH/WW	LEDCAN6/WH/CW	WHITE	6	1W LED	5"	5-1/8"
LEDCAN6/PL/WW	LEDCAN6/PL/CW	PLEXI	6	1W LED	5-9/16"	5-1/8"
POWER SUPPLY INCLUDED						

See page 56 for photometric chart

LED-Power Supply

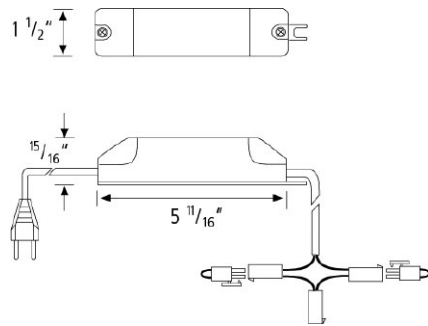

Electronic Power Supply For 9 x 1 W High-Power LEDs

Extremely small electronic power supply for max. 9 x 1 W high-power LEDs.

Electronic Power Supply For 18 x 1 W High-Power LEDs

Constant current electronic power supply for up to 18 W of high-power LEDs. This power supply works perfectly in all commercial and residential applications and features very small dimensions.

Product-Features

- 110 V, 50/60 Hz
- 350 mA constant current
- Overload protection
- Overheat protection
- Short-circuit protection
- Soft start for maximum LED life
- 79" plug-in power cord
- Attached terminal block for 3 x LED spotlights (PSLED/A)
- Two attached terminal blocks for 3 x LED spotlights (PSLED/18)
- Additional terminal blocks available

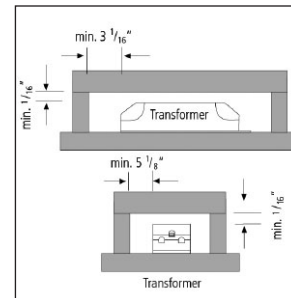

PSLED/A

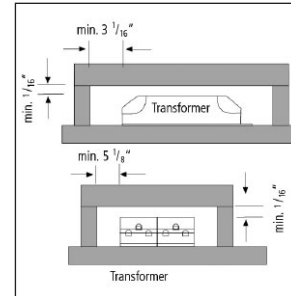

PSLED/18

MODEL NO	COLOR	DIMENSIONS			DESCRIPTION
		L	W	H	
POWER SUPPLY LED					
PSLED/A	WHITE	5-11/16"	1-1/2"	15/16"	9 X 1 W HIGH POWER LEDS
PSLED/18	WHITE	5-11/16"	3"	15/16"	18 X 1W HIGH POWER LEDS
PSLED/A/LINE	WHITE				SWITCH COMPATIBLE LED POWER SUPPLY
PSLED/ECO					POWER SUPPLY FOR ECO LED
PCM					POWER CONTROL MODULE
TBLED/A	BLACK				TERMINAL BLOCK
LED SWITCH	BLACK				ON/OFF SWITCH

Fluorescent-SlimLite Series



A Fluorescent So Compact, It Fits Even The Most Hard-To-Light Areas In Furniture, Displays Or Under Cabinets

The fixture is easy to install with a snap-in system. You can also combine several fixtures effortlessly. The modular connecting system makes it simple to create long, continuous lines of fluorescent lighting to fit any space. Its high light-output and an extremely low heat index make the SlimLite ideal for displays and cases.



Product-Features

- Built-in electronic ballast
- Energy efficient, only 7, 10, and 18 W
- Slender profile fits virtually any furniture, cabinet or display
- Attractive, easy to clean plexiglass cover protects bulb
- Instant starting, tri-phosphor lamp is quiet and flicker-free
- Plug-in modular system permits easy connection for continuous lighting up to 155W max
- Extremely long bulb life, rated 10,000 hrs.
- Contemporary white housing
- Available in three different lengths: 10", 13" and 20"; width 11/16"; height: 1-1/4"
- Available with T4 cool white (4100 K) or warm white (3450 K) bulb, CRI > 82

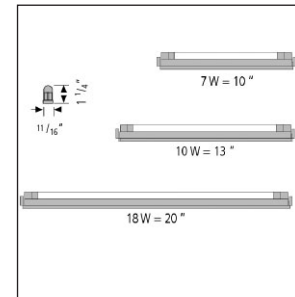

MODEL NO		COLOR	LAMPS		DIMENSIONS		
WARM WHITE	COOL WHITE		QTY	T4	L	W	H
ES10WW/P	ES10/P*	WHITE	1	7W	10"	11/16"	1-1/4"
ES13WW/P	ES13/P*	WHITE	1	10W	13"	11/16"	1-1/4"
ES20WW/P	ES20/P*	WHITE	1	18W	20"	11/16"	1-1/4"

* Previously American Fluorescent TSLP series

Slimlite Accessories

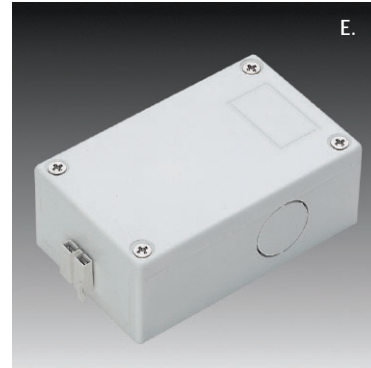
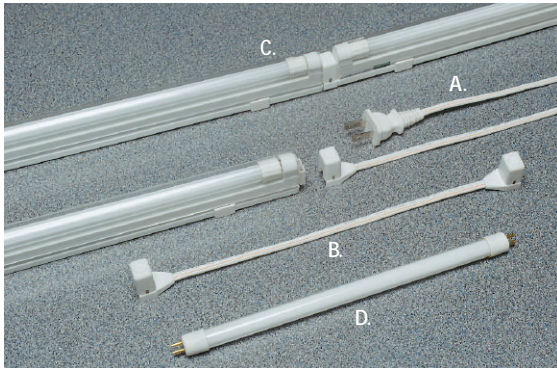

Accessories

MODEL NO	DESCRIPTION		
A. POWER CORD			
STANDARD END			
SPC6/XL	6" LONG		
SPC12/XL	12" LONG		
SPC24/XL	24" LONG		
SPC/XL*	72" LONG		
SPC/S/XL	72" LONG WITH ROLLER SWITCH		
SPC120/XL	120" LONG		
SPC/XL/CD	72" LONG WITH CONDUIT COVER		
90 DEGREE END			
SPC18/SP	18" LONG		
SPC36/SP	36" LONG		
SPC72/SP	72" LONG		
STRAIGHT END			
SPC15/STC	15" LONG		
SPC24/STC	24" LONG		
SPC48/STC	48" LONG		
SPC72/STC	72" LONG		
B. CONNECTING CABLES			
STANDARD END	STRAIGHT END	90 DEGREE END	
SCC6/XL*	SCC6/STC	SCC6/SP	6" LONG
SCC12/XL*	SCC12/STC	SCC12/SP	12" LONG
SCC24/XL*	SCC24/STC	SCC24/SP	24" LONG
SCC48/XL	SCC48/TC		48" LONG
SCC72/XL	SCC72/TC		72" LONG
SCC12/XL/CD (WITH CONDUIT COVER)			12" LONG
SCC48/XL/CD (WITH CONDUIT COVER)			48" LONG
C. DIRECT CONNECTOR			
SDC/XL*			
D. REPLACEMENT BULB			
SFB7CW	7W COOL WHITE		
SFB7WW	7W WARM WHITE		
SFB10CW	10W COOL WHITE		
SFB10WW	10W WARM WHITE		
SFB18CW	18W COOL WHITE		
SFB18WW	18W WARM WHITE		

MODEL NO	DESCRIPTION
E. HARDWIRE BOX	
SHWC/XL*	
SHWC/S/XL	WITH SWITCH
F. ON/OFF ROCKER SWITCH	
SRS/XL*	
G. MOUNTING CLIP	
SMC/T4	

* Previously American Fluorescent TSLP series

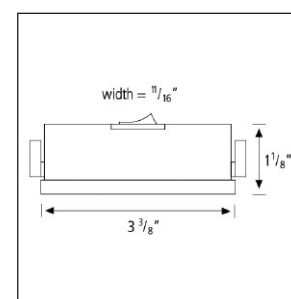
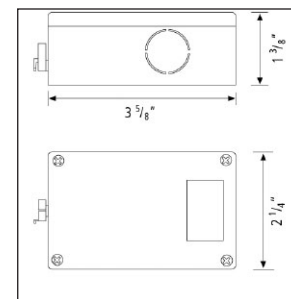

Fluorescent-SlimLite XL Series



For Longer Runs Our Slimlite XL Is The Solution

The XL offers all the benefits of SlimLite: It's cooler, brighter, more compact. And now it's available in 2', 3', 4' and 5' lengths. This enables continuous rows of light of up to 50 linear feet which makes the XL the perfect lighting system for gondolas, store fixtures and long runs of shelves. SlimLite XL features standard T-5 lamps which are available in a variety of light colors. Its optional plexiglass cover makes it also the preferred light fixture for food applications.

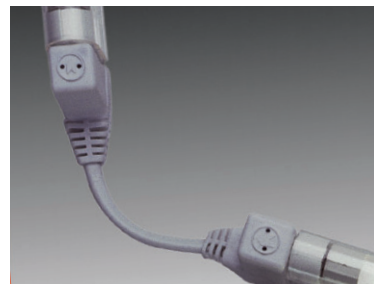

Product-Features

- Built-in electronic ballast
- Energy efficient, only 14, 21, 28, and 35 W
- Uses standard T-5 lamps, CRI > 82 (to be ordered separately)
- Plug-in modular system permits easy connection for continuous lighting
- Connect up to 395 W max.
- End of lamp life circuit protection
- Extremely long bulb life, rated 20,000 hrs.
- Contemporary white housing
- Available in four different lengths: 2' (23-1/8"), 3' (34-7/8"), 4' (46-3/4") and 5' (58-7/16") width 7/8", height 1-5/16"
- Optional plexiglass cover available (order separately)

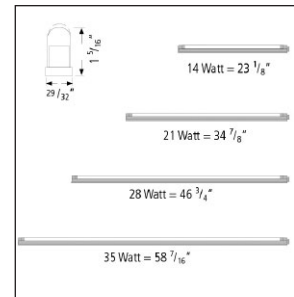

MODEL NO	COLOR	LAMPS	DIMENSIONS				
FIXTURE ONLY		QTY	T5	L	W	H	
ES22	WHITE	1	14W	23-1/8"	7/8"	1-5/16"	
ES34	WHITE	1	22W	34-7/8"	7/8"	1-5/16"	
ES46	WHITE	1	28W	46-3/4"	7/8"	1-5/16"	
ES59	WHITE	1	35W	58-7/16"	7/8"	1-5/16"	
WITH BULB AND COVER							
WARM WHITE	COOL WHITE						
ES22WW/BC	ES22/BC*	WHITE	1	14W	23-1/8"	7/8"	1-5/16"
ES34WW/BC	ES34/BC*	WHITE	1	22W	34-7/8"	7/8"	1-5/16"
ES46WW/BC	ES46/BC*	WHITE	1	28W	46-3/4"	7/8"	1-5/16"
ES59WW/BC	ES59/BC*	WHITE	1	35W	58-7/16"	7/8"	1-5/16"

* Previously American Fluorescent TSLP series

Slimlite XL Accessories

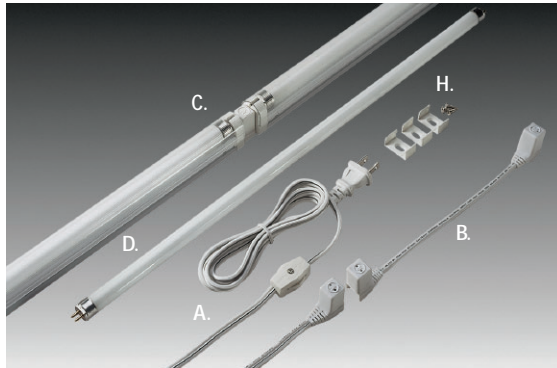

	ES22	ES34	ES46	ES59
(A) fixture length	23 1/8"	34 7/8"	46 3/8"	58 7/8"
(B) fixture width	2 9/16"	2 1/2"	2 9/16"	2 9/16"
(C) fixture height with diffuser	1 3/16"	1 1/8"	1 3/16"	1 3/16"
(D) tube length	21 1/2"	33 1/4"	45 1/8"	57"
(E) tube diameter	T5 (5/8")	T5 (5/8")	T5 (5/8")	T5 (5/8")
watts	14	21	28	35
lumens	1350	2100	2900	3650
current	240mA	350mA	450mA	510mA
in-rush current	less than 5 AMP			
CRI	> 82			
voltage	AC 120			
frequency	60 Hz			
maximum watts in line	390 Watts			

Accessories

MODEL NO	DESCRIPTION	
A. POWER CORD		
STANDARD END		
SPC6/XL	6" LONG	
SPC12/XL	12" LONG	
SPC24/XL	24" LONG	
SPC/XL	72" LONG	
SPC/S/XL	72" LONG WITH ROLLER SWITCH	
SPC120/XL	120" LONG	
SPC/XL/CD	72" LONG WITH CONDUIT COVER	
90 DEGREE END		
SPC18/SP	18" LONG	
SPC36/SP	36" LONG	
SPC72/SP	72" LONG	
STRAIGHT END		
SPC15/STC	15" LONG	
SPC24/STC	24" LONG	
SPC48/STC	48" LONG	
SPC72/STC	72" LONG	
B. CONNECTING CABLES		
STANDARD END	STRAIGHT END	90 DEGREE END
SCC6/XL*	SCC6/STC	SCC6/SP 6" LONG
SCC12/XL*	SCC12/STC	SCC12/SP 12" LONG
SCC24/XL*	SCC24/STC	SCC24/SP 24" LONG
SCC48/XL	SCC48/TC	48" LONG
SCC72/XL	SCC72/TC	72" LONG
SCC12/XL/CD (WITH CONDUIT COVER)		12" LONG
SCC48/XL/CD (WITH CONDUIT COVER)		48" LONG
DIRECT CONNECTOR		
SDC/XL*		
SCC12/XL/CD	12" LONG WITH CONDUIT COVER	
SCC48/XL/CD	48" LONG WITH CONDUIT COVER	

MODEL NO	DESCRIPTION
D. REPLACEMENT BULB	
SFB14CW	14W COOL WHITE
SFB14WW	14W WARM WHITE
SFB21CW	21W COOL WHITE
SFB21WW	21W WARM WHITE
SFB28CW	28W COOL WHITE
SFB28WW	28W WARM WHITE
SFB35CW	35W COOL WHITE
SFB35WW	35W WARM WHITE
E. HARDWIRE BOX	
SHWC/XL*	
SHWC/S/XL	WITH SWITCH
F. ON/OFF ROCKER SWITCH	
SRS/XL*	
G. PLEXIGLASS COVER	
SPLX22	FOR ES22
SPLX34	FOR ES43
SPLX46	FOR ES46
SPLX59	FOR ES59
H. MOUNTING CLIPS	
SMC/XL/METAL	0° FLAT MOUNT
SMC/XL/S90	90° SIDE MOUNT
SMC/XL/S45	45° SIDE MOUNT
SEC	END CAP
I. ALUMINUM EXTRUSION	
EX22	ALUMINUM
EX22WH	WHITE
EX22A	ALMOND
EX34	ALUMINUM
EX34WH	WHITE
EX34A	ALMOND
EX46	ALUMINUM
EX46FWH	WHITE
EX46A	ALMOND

* Previously American Fluorescent TSLP series

Fluorescent-HighLite Series



A Stylish New Way to Light Your Displays

HighLite from Hera offers an innovative, beautiful and easy alternative to illuminate your displays. In fact, HighLite is so attractive, you won't want to hide it. Now you have a complete, off the shelf solution which is simple to design into all your displays. Its sleek, smart design looks great anywhere.

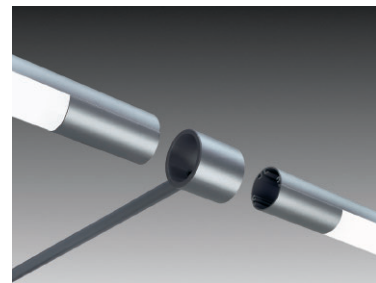

Product-Features

- Round brushed anodized aluminum housing
- Includes plexiglass cover
- Two different lengths of mounting stems available (11-3/8" and 19-5/8")
- Can be installed vertically or horizontally
- Built-in electronic ballast
- Energy efficient, only 14, 21, 28, and 35 W
- Uses standard T-5 lamps, CRI > 82
- Plug-in modular system and connecting elements permit easy, seamless connection for continuous lighting
- Extremely long bulb life, rated 20,000 hrs.
- Lighting element available in four different lengths: 2' (30-3/8"), 3' (42-1/8"), 4' (54"), 5' (65-3/4")
- Diameter: 1-3/4"
- Optional wall mounting plate available, fits 4" junction boxes (HLWMP)

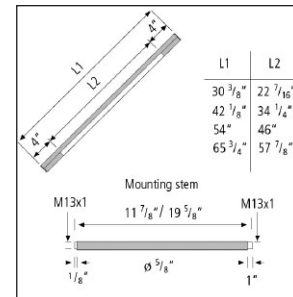

MODEL NO	COLOR	LAMPS		DIMENSIONS	
		QTY	T5	L	DIA
HL30	ALUMINUM	1	14W	30-3/8"	1-3/4"
HL42	ALUMINUM	1	21W	42-1/8"	1-3/4"
HL54	ALUMINUM	1	28W	54"	1-3/4"
HL65	ALUMINUM	1	35W	65-3/4"	1-3/4"

Highlite Accessories



Accessories

MODEL NO	DESCRIPTION
POWER CORD	
SPC/HL	72" LONG
CONNECTING CABLE	
SCC12/XL	12" LONG
REPLACEMENT BULB	
SFB14CW	14W COOL WHITE
SFB14WW	14W WARM WHITE
SFB21CW	21W COOL WHITE
SFB21WW	21W WARM WHITE
SFB28CW	28W COOL WHITE
SFB28WW	28W WARM WHITE
SFB35CW	35W COOL WHITE
SFB35WW	35W WARM WHITE
MOUNTING STEM	
HLMS11	11-7/8" LONG
HLMS19	19-5/8" LONG
CONNECTING ELEMENT	
HLC	
END PIECE	
HLE	
WALL MOUNTING PLATE	
HLWMP	

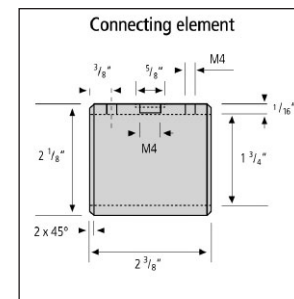
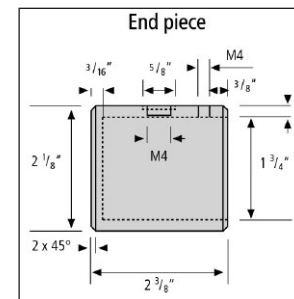

Fluorescent-FluoroSpot Series



Another Revolutionary Light Fixture For Under-Cabinet And Display Lighting

This fluorescent spotlight features an integrated electronic ballast and 6,000 hours lamp life. A remote transformer is not necessary. Some of the main benefits are: easy installation, high light output and compact size. In addition, FluoroSpot uses only 7 W of energy while providing almost the same light output as 20 W halogen spot. FluoroSpot can be recessed, semi-recessed and surface mounted.

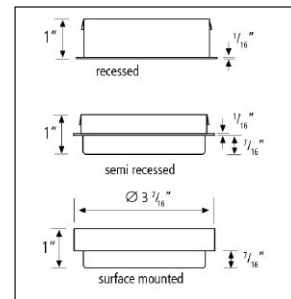

Product-Features

- Fluorescent spotlight for recess, semi-recess or surface mounting (comes with three rings)
- Recess depth only 1" or 1/2" with semi-recess ring
- Integrated electronic ballast, no additional transformer needed
- 7 W warm white (3,000 K) or cool white (4,000 K) lamp included
- 6,000 hours lamp life
- Attached 79" power cord
- Available in white and brushed aluminum

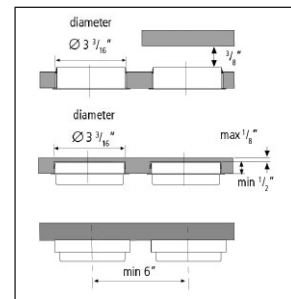

MODEL NO		COLOR	LAMPS		DIMENSIONS	
WARM WHITE	COOL WHITE		QTY		D	DIA
FS7WW/WH	FS7/WH	WHITE	1	7W	1"	3-7/16"
FS7WW/BA	FS7/BA	ALUMINUM	1	7W	1"	3-7/16"
REPLACEMENT LAMP						
FSB7/WW	FSB7		1	7W		

Xenon-XR1/XS1 Series



Surface And Recessed Mounted Xenon Spotlights

Accent lighting for vanities, displays, furniture, kitchen cabinets or boats. Hera Xenon fixtures combine the advantages of a long bulb life and lower bulb temperatures.

Product-Features

- Recess depth only 5/8"
- Aluminum reflector
- Frosted tempered glass lens
- Easy to relamp
- 12 V/18 W xenon bulb included, 8,000 hrs. lifetime
- Attached 79" connecting cable with NV6 plug
- Available in white, black, chrome, stainless steel and gold
- To be used with Hera electronic transfers
- Accessories available. See page 48

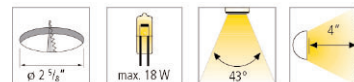
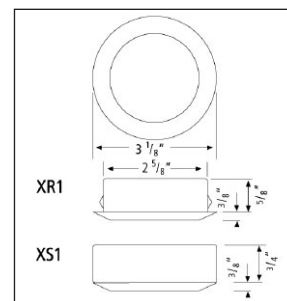

MODEL NO	COLOR	LAMPS		DIMENSIONS	
		QTY	XENON	D	DIA
RECESS MOUNTED					
XR1WH	WHITE	1	18W	1"	3-1/8"
XR1BL	BLACK	1	18W	1"	3-1/8"
XR1CH	CHROME	1	18W	1"	3-1/8"
XR1GO	GOLD	1	18W	1"	3-1/8"
XR1SS	STAINLESS	1	18W	1"	3-1/8"
SURFACE MOUNTED					
XS1WH*	WHITE	1	18W	1-1/8"	3-1/8"
XS1BL*	BLACK	1	18W	1-1/8"	3-1/8"
XS1CH*	CHROME	1	18W	1-1/8"	3-1/8"
XS1GO*	GOLD	1	18W	1-1/8"	3-1/8"
XS1SS*	STAINLESS	1	18W	1-1/8"	3-1/8"
POWER SUPPLY		DESCRIPTION			
UC-60FT		60 W PREMIUM ELECTRONIC TRANSFORMER, 6' CORD-N-PLUG (CONNECT UP TO 3 LIGHTS)			
UE-E60FT**		60 W ECOLINE ELECTRONIC TRANSFORMER, 6' CORD-N-PLUG (CONNECT UP TO 3 LIGHTS)			
UK-120TW		120 W PREMIUM ELECTRONIC TRANSFORMER (CONNECT UP TO 6 LIGHTS)			
HT-150***		(3) - 60 W OUTPUTS, CLASS II TRANSFORMER, REMOTE MOUNT, HARDWIRE ONLY			
HT-300***		(6) - 60 W OUTPUTS, CLASS II TRANSFORMER, REMOTE MOUNT, HARDWIRE ONLY			

* Previously American Fluorescent XP1 series
 ** Previously American Fluorescent part # HT-60
 *** Item is only supplied as American Fluorescent brand

Halogen-KB12/KBS12 Series



Compact Surface Or Recessed Mounted Spotlight

Designed for various applications, e.g. kitchen cabinets, display cases, exhibits, etc. Ideal for installation in wood and sheet metal.

Product-Features

- Recess depth 5/8" or 1/2" (with spacer ring R12)
- Highly polished aluminum reflector, friction fit, easy to relamp
- Clear lens, optional frosted glass lens available (KBGLFR)
- Includes 12 V/10 or 20 W 4,000 hr. Osram bulb
- Attached 72" connecting cable with NV6 plug
- Available in white, black, chrome, stainless steel and gold
- Can be used with 10,000 hrs. xenon bi-pin bulb (special order)
- Available in complete sets of 2, 3, or 5 lights. See page 28
- Accessories available. See page 47

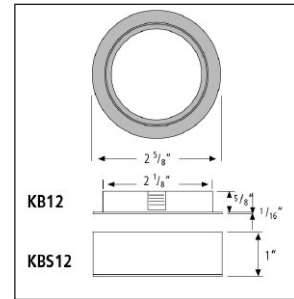

MODEL NO	COLOR	LAMPS		DIMENSIONS	
		QTY	HALOGEN	D	DIA
RECESS MOUNTED					
KB1210WH	WHITE	1	10W	11/16"	2-5/8"
KB1210BL	BLACK	1	10W	11/16"	2-5/8"
KB1210CH	CHROME	1	10W	11/16"	2-5/8"
KB1210GO	GOLD	1	10W	11/16"	2-5/8"
KB1210SS	STAINLESS	1	10W	11/16"	2-5/8"
KB1220WH	WHITE	1	20W	11/16"	2-5/8"
KB1220BL	BLACK	1	20W	11/16"	2-5/8"
KB1220CH	CHROME	1	20W	11/16"	2-5/8"
KB1220GO	GOLD	1	20W	11/16"	2-5/8"
KB1220SS	STAINLESS	1	20W	11/16"	2-5/8"
SURFACE MOUNTED					
KBS1210WH	WHITE	1	10W	1"	2-5/8"
KBS1210BL	BLACK	1	10W	1"	2-5/8"
KBS1210CH	CHROME	1	10W	1"	2-5/8"
KBS1210GO	GOLD	1	10W	1"	2-5/8"
KBS1210SS	STAINLESS	1	10W	1"	2-5/8"
KBS1220WH	WHITE	1	20W	1"	2-5/8"
KBS1220BL	BLACK	1	20W	1"	2-5/8"
KBS1220CH	CHROME	1	20W	1"	2-5/8"
KBS1220GO	GOLD	1	20W	1"	2-5/8"
KBS1220SS	STAINLESS	1	20W	1"	2-5/8"

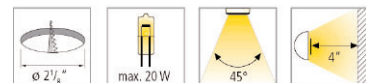

POWER SUPPLY	
UC-60FT	60 W PREMIUM ELECTRONIC TRANSFORMER, 6' CORD-N-PLUG (CONNECT UP TO 3 LIGHTS)
UE-E60FT*	60 W ECOLINE ELECTRONIC TRANSFORMER, 6' CORD-N-PLUG (CONNECT UP TO 3 LIGHTS)
UK-120TW	120 W PREMIUM ELECTRONIC TRANSFORMER (CONNECT UP TO 6 LIGHTS)
HT-150**	(3) - 60 W OUTPUTS, CLASS II TRANSFORMER, REMOTE MOUNT, HARDWIRE ONLY
HT-300**	(6) - 60 W OUTPUTS, CLASS II TRANSFORMER, REMOTE MOUNT, HARDWIRE ONLY

* Previously American Fluorescent part # HT-60

**Item is only supplied as American Fluorescent brand

KBS12 Premium Sets



KBS12 Sets

These low voltage sets consist of halogen spotlights (for recessed or surface mounting), UC-60FT or UK-120TW (5 light sets) transformers, connecting cables and all hardware to make the installation easy.

Product-Features

- Available in white, black, chrome, gold and stainless steel
- The sets are packaged in an attractive carton suitable for display
- Available in 2, 3 or 5 light sets



MODEL NO	COLOR	LAMPS		DIMENSIONS	
		QTY	HALOGEN	D	DIA
2 LIGHT SET					
E/SET1KBS20WH	WHITE	1	20W	1"	2-5/8"
E/SET1KBS20BL	BLACK	1	20W	1"	2-5/8"
E/SET1KBS20CH	CHROME	1	20W	1"	2-5/8"
E/SET1KBS20GO	GOLD	1	20W	1"	2-5/8"
E/SET1KBS20SS	STAINLESS	1	20W	1"	2-5/8"
3 LIGHT SET					
E/SET2KBS20WH	WHITE	1	20W	1"	2-5/8"
E/SET2KBS20BL	BLACK	1	20W	1"	2-5/8"
E/SET2KBS20CH	CHROME	1	20W	1"	2-5/8"
E/SET2KBS20GO	GOLD	1	20W	1"	2-5/8"
E/SET2KBS20SS	STAINLESS	1	20W	1"	2-5/8"
5 LIGHT SET					
E/SET3KBS20WH	WHITE	1	20W	1"	2-5/8"
E/SET3KBS20BL	BLACK	1	20W	1"	2-5/8"
E/SET3KBS20CH	CHROME	1	20W	1"	2-5/8"
E/SET3KBS20GO	GOLD	1	20W	1"	2-5/8"
E/SET3KBS20SS	STAINLESS	1	20W	1"	2-5/8"
POWER SUPPLY INCLUDED					

Halogen-ARF20/ARFS20 Series



Low-Profile Recessed Or Surface Mounted Halogen Spotlight

This friction fit spotlight is designed for installation in kitchen cabinets, display cases and furniture. The ARF is the highest quality halogen spotlight and perfectly suitable for commercial applications.

Product-Features

- Recess depth only 5/8 or 1/2" (with spacer ring DR13)
- Highly polished aluminum reflector, friction fit, easy to relamp
- Includes 12 V/10 or 20 W 4,000 hr. Osram bulb
- Same design as CBS20 but for the under-the-cabinet applications
- Overall surface height less than 1/16"
- Frosted tempered glass lens
- Attached 72" connecting cable with NV6 plug
- Available in white, black, chrome, stainless steel and gold
- Can be used with 10,000 hrs. xenon bi-pin bulb (special order)
- ARFS20 available in complete sets of 2, 3, or 5 lights. See page 30
- Accessories available. See page 47

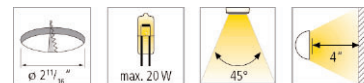
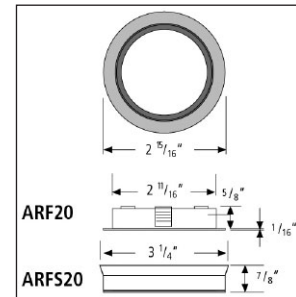

MODEL NO	COLOR	LAMPS		DIMENSIONS	
		QTY	HALOGEN	D	DIA
RECESS MOUNTED					
ARF20WH	WHITE	1	20W	1 1/16"	2-15/16"
ARF20BL	BLACK	1	20W	1 1/16"	2-15/16"
ARF20CH	CHROME	1	20W	1 1/16"	2-15/16"
ARF20GO	GOLD	1	20W	1 1/16"	2-15/16"
ARF20SS	STAINLESS	1	20W	1 1/16"	2-15/16"
SURFACE MOUNTED					
ARFS20WH	WHITE	1	20W	7/8"	2-15/16"
ARFS20BL	BLACK	1	20W	7/8"	2-15/16"
ARFS20CH	CHROME	1	20W	7/8"	2-15/16"
ARFS20GO	GOLD	1	20W	7/8"	2-15/16"
ARFS20SS	STAINLESS	1	20W	7/8"	2-15/16"
POWER SUPPLY		DESCRIPTION			
UC-60FT		60 W PREMIUM ELECTRONIC TRANSFORMER, 6' CORD-N-PLUG (CONNECT UP TO 3 LIGHTS)			
UE-E60FT*		60 W ECOLINE ELECTRONIC TRANSFORMER, 6' CORD-N-PLUG (CONNECT UP TO 3 LIGHTS)			
UK-120TW		120 W PREMIUM ELECTRONIC TRANSFORMER (CONNECT UP TO 6 LIGHTS)			
HT-150**		(3) - 60 W OUTPUTS, CLASS II TRANSFORMER, REMOTE MOUNT, HARDWIRE ONLY			
HT-300**		(6) - 60 W OUTPUTS, CLASS II TRANSFORMER, REMOTE MOUNT, HARDWIRE ONLY			

* Previously American Fluorescent part # HT-60

**Item is only supplied as American Fluorescent brand

ARFS20 Premium Sets



ARFS Sets

These low voltage sets consist of halogen spotlights (for recessed or surface mounting), UC-60FT or UK-120TW (5 light sets) transformers, connecting cables and all hardware to make the installation easy.

Product-Features

- Available in white, black, chrome, gold and stainless steel
- The sets are packaged in an attractive carton suitable for display
- Available in 2, 3 or 5 light sets



MODEL NO	COLOR	LAMPS		DIMENSIONS	
		QTY	HALOGEN	D	DIA
2 LIGHT SET					
E/SET1ARFS20WH	WHITE	1	20W	7/8"	2-15/16"
E/SET1ARFS20BL	BLACK	1	20W	7/8"	2-15/16"
E/SET1ARFS20CH	CHROME	1	20W	7/8"	2-15/16"
E/SET1ARFS20GO	GOLD	1	20W	7/8"	2-15/16"
E/SET1ARFS20SS	STAINLESS	1	20W	7/8"	2-15/16"
3 LIGHT SET					
E/SET2ARFS20WH	WHITE	1	20W	7/8"	2-15/16"
E/SET2ARFS20BL	BLACK	1	20W	7/8"	2-15/16"
E/SET2ARFS20CH	CHROME	1	20W	7/8"	2-15/16"
E/SET2ARFS20GO	GOLD	1	20W	7/8"	2-15/16"
E/SET2ARFS20SS	STAINLESS	1	20W	7/8"	2-15/16"
5 LIGHT SET					
E/SET3ARFS20WH	WHITE	1	20W	7/8"	2-15/16"
E/SET3ARFS20BL	BLACK	1	20W	7/8"	2-15/16"
E/SET3ARFS20CH	CHROME	1	20W	7/8"	2-15/16"
E/SET3ARFS20GO	GOLD	1	20W	7/8"	2-15/16"
E/SET3ARFS20SS	STAINLESS	1	20W	7/8"	2-15/16"
POWER SUPPLY INCLUDED					

Halogen-EH24 Series



Recessed Swivel Halogen Spotlight

Ideally suited for installation inside cabinets, furniture and showcases as accent lighting, direct illumination, etc.

Product-Features

- +/- 20 degree swivel
- Recess depth only 1-3/4"
- Metal housing
- Includes 12 V/20 W lensed MR11 bulb
- Attached 6" connecting cable with NV6 plug
- Can be relamped from top or bottom
- Available in white, black, chrome, gold and stainless steel
- 4" clearance in height and 13-3/4" across on backside of fixture is necessary
- Includes 79" connecting cable
- Also available in complete kits of 2, 3 or 5 lights. See page 32

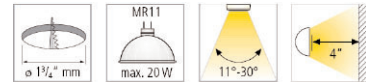
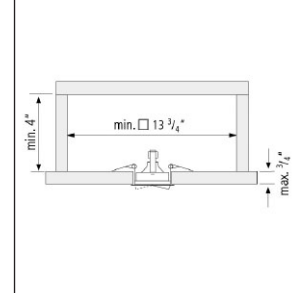
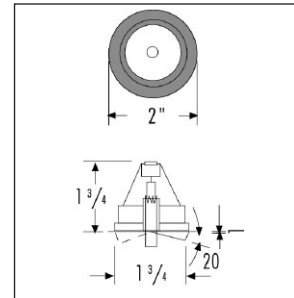

MODEL NO	COLOR	LAMPS		DIMENSIONS	
		QTY	HALOGEN	D	DIA
EH2420WH	WHITE	1	20W MR11	1-3/4"	2"
EH2420BL	BLACK	1	20W MR11	1-3/4"	2"
EH2420CH	CHROME	1	20W MR11	1-3/4"	2"
EH2420GO	GOLD	1	20W MR11	1-3/4"	2"
EH2420SS	STAINLESS	1	20W MR11	1-3/4"	2"
POWER SUPPLY	DESCRIPTION				
UC-60FT	60 W PREMIUM ELECTRONIC TRANSFORMER, 6' CORD-N-PLUG (CONNECT UP TO 3 LIGHTS)				
UE-E60FT*	60 W ECOLINE ELECTRONIC TRANSFORMER, 6' CORD-N-PLUG (CONNECT UP TO 3 LIGHTS)				
UK-120TW	120 W PREMIUM ELECTRONIC TRANSFORMER (CONNECT UP TO 6 LIGHTS)				
HT-150**	(3) - 60 W OUTPUTS, CLASS II TRANSFORMER, REMOTE MOUNT, HARDWIRE ONLY				
HT-300**	(6) - 60 W OUTPUTS, CLASS II TRANSFORMER, REMOTE MOUNT, HARDWIRE ONLY				

* Previously American Fluorescent part # HT-60

**Item is only supplied as American Fluorescent brand

EH24 Premium Sets



EH24 Sets

These low voltage sets consist of halogen spotlights (for recessed or surface mounting), UC-60FT or UK-120TW (5 light sets) transformers, connecting cables and all hardware to make the installation easy.

Product-Features

- Available in white, black, chrome and gold
- The sets are packaged in an attractive carton suitable for display
- Available in 2, 3 or 5 light sets



MODEL NO	COLOR	LAMPS		DIMENSIONS	
		QTY	HALOGEN	D	DIA
2 LIGHT SET					
E/SET1EH24WH	WHITE	1	20W MR11	1-3/4"	2"
E/SET1EH24BL	BLACK	1	20W MR11	1-3/4"	2"
E/SET1EH24CH	CHROME	1	20W MR11	1-3/4"	2"
E/SET1EH24GO	GOLD	1	20W MR11	1-3/4"	2"
3 LIGHT SET					
E/SET2EH24WH	WHITE	1	20W MR11	1-3/4"	2"
E/SET2EH24BL	BLACK	1	20W MR11	1-3/4"	2"
E/SET2EH24CH	CHROME	1	20W MR11	1-3/4"	2"
E/SET2EH24GO	GOLD	1	20W MR11	1-3/4"	2"
5 LIGHT SET					
E/SET3EH24WH	WHITE	1	20W MR11	1-3/4"	2"
E/SET3EH24BL	BLACK	1	20W MR11	1-3/4"	2"
E/SET3EH24CH	CHROME	1	20W MR11	1-3/4"	2"
E/SET3EH24GO	GOLD	1	20W MR11	1-3/4"	2"
POWER SUPPLY INCLUDED					

Halogen-Arclamp Series



The Overwhelming Light Fixture

Attractive design, easy to install, various applications, e.g. kitchen, bathroom and living room. Also perfect for displays or exhibition booths.

Product-Features

BLG1/BLG2

- Swivel head
- High quality metal housing
- Easy installation using welded hold down clamp (2 screws)
- Long life 20 W or 50 W lensed MR16 bulb included
- Attached 6" connecting cable with NV6 plug
- High light output while using minimum energy
- Easy lamp replacement
- Available in chrome, gold, matte nickel, matte chrome, black and white
- Special order colors and sizes are available for minimum quantities
- Includes 79" connecting cable

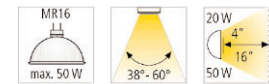
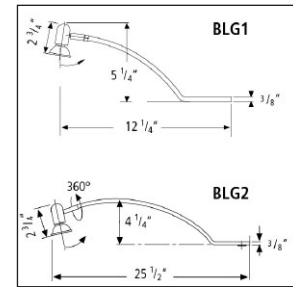

MODEL NO	COLOR	LAMPS	DIMENSIONS	
SWIVEL HEAD		QTY	HALOGEN	L DIA (HEAD)
BLG1/20WH	WHITE	1	20W MR16	12-1/4" 2-3/4"
BLG1/20BL	BLACK	1	20W MR16	12-1/4" 2-3/4"
BLG1/20CH	CHROME	1	20W MR16	12-1/4" 2-3/4"
BLG1/20NI	MATTE NICKEL	1	20W MR16	12-1/4" 2-3/4"
BLG1/20MCH	MATTE CHROME	1	20W MR16	12-1/4" 2-3/4"
BLG2/50WH	WHITE	1	50W MR16	25-1/2" 2-3/4"
BLG2/50BL	BLACK	1	50W MR16	25-1/2" 2-3/4"
BLG2/50CH	CHROME	1	50W MR16	25-1/2" 2-3/4"
BLG2/50GO	GOLD	1	50W MR16	25-1/2" 2-3/4"
BLG2/50NI	MATTE NICKEL	1	50W MR16	25-1/2" 2-3/4"
BLG2/50MCH	MATTE CHROME	1	50W MR16	25-1/2" 2-3/4"
POWER SUPPLY	DESCRIPTION			
UC-60FT	60 W PREMIUM ELECTRONIC TRANSFORMER, 6' CORD-N-PLUG (CONNECT UP TO 3 LIGHTS)			
UE-E60FT*	60 W ECOLINE ELECTRONIC TRANSFORMER, 6' CORD-N-PLUG (CONNECT UP TO 3 LIGHTS)			
UK-120TW	120 W PREMIUM ELECTRONIC TRANSFORMER (CONNECT UP TO 6 LIGHTS)			
HT-150**	(3) - 60 W OUTPUTS, CLASS II TRANSFORMER, REMOTE MOUNT, HARDWIRE ONLY			
HT-300**	(6) - 60 W OUTPUTS, CLASS II TRANSFORMER, REMOTE MOUNT, HARDWIRE ONLY			

* Previously American Fluorescent part # HT-60

**Item is only supplied as American Fluorescent brand

Halogen-Antique Arclamp Series



Features Traditional Design Elements Combined With Modern Halogen Technology

Developed for use on kitchen cabinets, displays and bathroom vanities. The fixture is available in two attractive finishes (antique copper and antique brass) and comes with a frosted glass shade. Featuring Hera's unique connecting system, it can be easily integrated into any new or existing Hera low-voltage halogen system. The Antique Arclamp adds that special design touch to today's traditional kitchens.

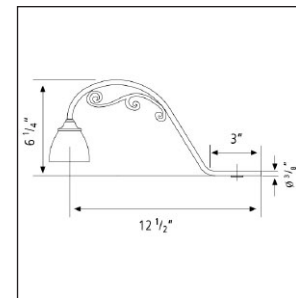

Product-Features

- Frosted glass shade
- Includes 12 V/20 W 4,000 hr. Osram bulb
- Attached 6" connecting cable with NV6 plug
- Easy installation using welded hold down clamp (2 screws)
- Standard finishes: antique copper and antique brass
- Special order finish: antique pewter (min. 100 pcs.)
- Custom colors and sizes are available for minimum quantities
- Includes 79" connecting cable

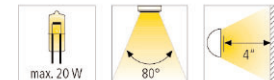

MODEL NO	COLOR	LAMPS		DIMENSIONS	
		QTY	HALOGEN	L	DIA (HEAD)
BL1CO/A	ANTIQUE COPPER	1	20W	12-1/2"	6-1/4"
BL1BB/A	ANTIQUE BRASS	1	20W	12-1/2"	6-1/4"
POWER SUPPLY	DESCRIPTION				
UC-60FT	60 W PREMIUM ELECTRONIC TRANSFORMER, 6' CORD-N-PLUG (CONNECT UP TO 3 LIGHTS)				
UE-E60FT*	60 W ECOLINE ELECTRONIC TRANSFORMER, 6' CORD-N-PLUG (CONNECT UP TO 3 LIGHTS)				
UK-120TW	120 W PREMIUM ELECTRONIC TRANSFORMER (CONNECT UP TO 6 LIGHTS)				
HT-150**	(3) - 60 W OUTPUTS, CLASS II TRANSFORMER, REMOTE MOUNT, HARDWIRE ONLY				
HT-300**	(6) - 60 W OUTPUTS, CLASS II TRANSFORMER, REMOTE MOUNT, HARDWIRE ONLY				

* Previously American Fluorescent part # HT-60

**Item is only supplied as American Fluorescent brand

Halogen-ArcTech Series



Light Years Ahead In Simplicity And Style

Graceful stainless steel arc. "Effortless" installation. Ready to connect with Hera plug-in system. The ArcTech luminaire is poetry in motion over bookshelves, cabinets and entertainment areas.

Product-Features

- High quality housing of brushed stainless steel
- Includes integrated halogen spot MH14, 12V/20 W 4,000 hr. Osram bulb
- Convenient integration into Hera halogen systems
- Decorative cone and trim ring available in stainless steel
- Can be used with 10,000 hrs. Xenon bi-pin bulb (special order)
- To be used with Hera electronic transformers
- Includes 79" connecting cable

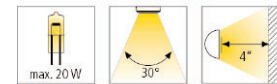
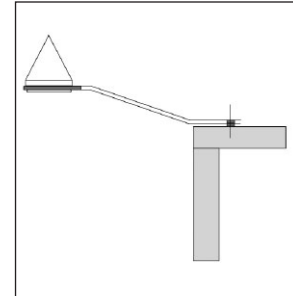
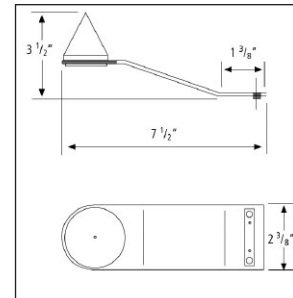

MODEL NO	COLOR	LAMPS		DIMENSIONS		
		QTY	HALOGEN	L	W	H
AL20SS	STAINLESS	1	20W	7-1/2"	2-3/8"	3-1/2"
POWER SUPPLY	DESCRIPTION					
UC-60FT	60 W PREMIUM ELECTRONIC TRANSFORMER, 6' CORD-N-PLUG (CONNECT UP TO 3 LIGHTS)					
UE-E60FT*	60 W ECOLINE ELECTRONIC TRANSFORMER, 6' CORD-N-PLUG (CONNECT UP TO 3 LIGHTS)					
UK-120TW	120 W PREMIUM ELECTRONIC TRANSFORMER (CONNECT UP TO 6 LIGHTS)					
HT-150**	(3) - 60 W OUTPUTS, CLASS II TRANSFORMER, REMOTE MOUNT, HARDWIRE ONLY					
HT-300**	(6) - 60 W OUTPUTS, CLASS II TRANSFORMER, REMOTE MOUNT, HARDWIRE ONLY					

* Previously American Fluorescent part # HT-60

**Item is only supplied as American Fluorescent brand

Halogen-Wave Series



The Latest Design Innovation For Under-Cabinet Applications

Innovative lighting design for innovative furniture, cabinet and display creations. Wave is available with halogen or energy saving fluorescent technology.

Product-Features

- Available with integrated ARF12 V/20 W halogen lamp
- Special order only, 7 W fluorescent lamp
- Transformer is needed for halogen version
- Extremely easy installation with only one screw
- Attached 70" connecting cable
- Finishes: matte chrome or stainless steel

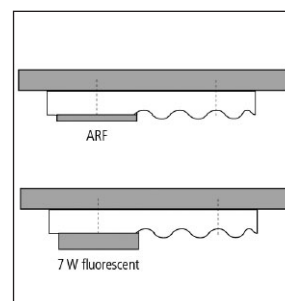
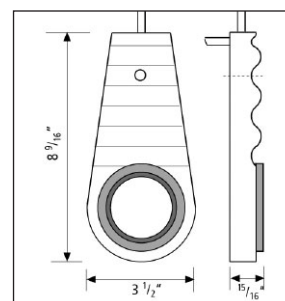

For halogen version

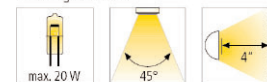

MODEL NO	COLOR	LAMPS		DIMENSIONS		
		QTY	HALOGEN	L	W	H
ARFWAVEMCH	MATTE CHROME	1	20W	8-9/16"	3-1/2"	15/16"
ARFWAVESS	STAINLESS	1	20W	8-9/16"	3-1/2"	15/16"
POWER SUPPLY	DESCRIPTION					
UC-60FT	60 W PREMIUM ELECTRONIC TRANSFORMER, 6' CORD-N-PLUG (CONNECT UP TO 3 LIGHTS)					
UE-E60FT*	60 W ECOLINE ELECTRONIC TRANSFORMER, 6' CORD-N-PLUG (CONNECT UP TO 3 LIGHTS)					
UK-120TW	120 W PREMIUM ELECTRONIC TRANSFORMER (CONNECT UP TO 6 LIGHTS)					
HT-150**	(3) - 60 W OUTPUTS, CLASS II TRANSFORMER, REMOTE MOUNT, HARDWIRE ONLY					
HT-300**	(6) - 60 W OUTPUTS, CLASS II TRANSFORMER, REMOTE MOUNT, HARDWIRE ONLY					

* Previously American Fluorescent part # HT-60

**Item is only supplied as American Fluorescent brand

Halogen-Enterprise Series

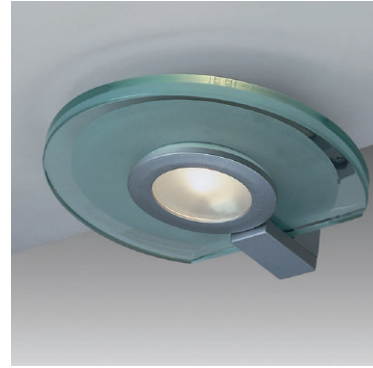

The Innovative Design Solution For Undercabinet Lighting

Enterprise will be the new focal point in your furniture, cabinets and displays. The partially frosted glass disk with integrated halogen spotlight provides direct illumination of the work area and indirect edge-lighting, creating a unique lighting accent. Enterprise is extremely easy to install with only two supplied screws. The cord is conveniently hidden by the mounting bracket.

Product-Features

- Easy surface mount installation with only two screws
- Angled mounting bracket for perfect illumination of the work area
- Partially frosted glass disk creates unique edge-lighting accent
- Mounting bracket and decor ring in matte chrome finish
- Easy to relamp
- 12V/20 W bulb included
- Attached 79" connecting cable with NV6 plug
- To be used with Hera electronic transformers

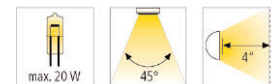
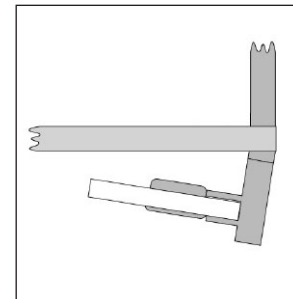
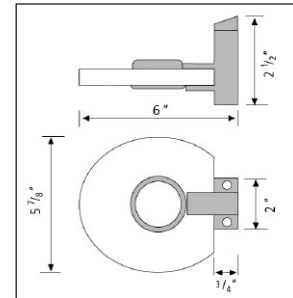

MODEL NO	COLOR	LAMPS		DIMENSIONS		
		QTY	HALOGEN	L	W	H
EN20PF	MATTE CHROME	1	20W	6"	5-7/8"	2-1/2"
POWER SUPPLY	DESCRIPTION					
UC-60FT	60 W PREMIUM ELECTRONIC TRANSFORMER, 6' CORD-N-PLUG (CONNECT UP TO 3 LIGHTS)					
UE-E60FT*	60 W ECOLINE ELECTRONIC TRANSFORMER, 6' CORD-N-PLUG (CONNECT UP TO 3 LIGHTS)					
UK-120TW	120 W PREMIUM ELECTRONIC TRANSFORMER (CONNECT UP TO 6 LIGHTS)					
HT-150**	(3) - 60 W OUTPUTS, CLASS II TRANSFORMER, REMOTE MOUNT, HARDWIRE ONLY					
HT-300**	(6) - 60 W OUTPUTS, CLASS II TRANSFORMER, REMOTE MOUNT, HARDWIRE ONLY					

* Previously American Fluorescent part # HT-60
 **Item is only supplied as American Fluorescent brand

Halogen-TriTech Series



Light Years Ahead In Form And Function

Elegant stainless steel housing. Ready to connect with the convenient Hera plug-in system. The stylish TriTech goes under cabinets and over entertainment areas, enriching your beautiful design.

Product-Features

- High quality triangle housing available in brushed stainless steel, copper and white
- Extremely easy installation with only one screw
- Convenient integration into Hera halogen systems
- Includes halogen spot KB12 V/20 W 4,000 hr. Osram bulb
- Attached 72" connecting cable
- Can be used with 10,000 hrs. Xenon bi-pin bulb (special order)
- To be used with Hera electronic transformers

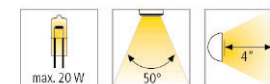
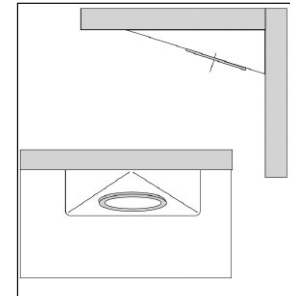
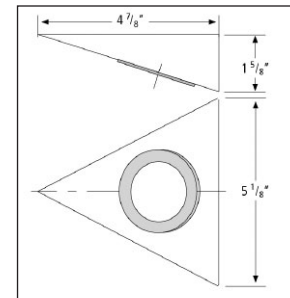

MODEL NO	COLOR	LAMPS		DIMENSIONS		
		QTY	HALOGEN	L	W	H
TR20CO	COPPER	1	20W	4-7/8"	5-1/8"	1-5/8"
TR20SS	STAINLESS	1	20W	4-7/8"	5-1/8"	1-5/8"
TR20WH	WHITE	1	20W	4-7/8"	5-1/8"	1-5/8"
POWER SUPPLY	DESCRIPTION					
UC-60FT	60 W PREMIUM ELECTRONIC TRANSFORMER, 6' CORD-N-PLUG (CONNECT UP TO 3 LIGHTS)					
UE-E60FT*	60 W ECOLINE ELECTRONIC TRANSFORMER, 6' CORD-N-PLUG (CONNECT UP TO 3 LIGHTS)					
UK-120TW	120 W PREMIUM ELECTRONIC TRANSFORMER (CONNECT UP TO 6 LIGHTS)					
HT-150**	(3) - 60 W OUTPUTS, CLASS II TRANSFORMER, REMOTE MOUNT, HARDWIRE ONLY					
HT-300**	(6) - 60 W OUTPUTS, CLASS II TRANSFORMER, REMOTE MOUNT, HARDWIRE ONLY					

* Previously American Fluorescent part # HT-60

**Item is only supplied as American Fluorescent brand

Halogen-CBS20 Series



Thermally Optimized Recessed Halogen Spotlight

More safety and convenience through thermal optimization. The light can remain switched on even when a door stops directly under the spotlight. This spotlight has international patents. There is nothing else like it.

Product-Features

- For applications where doors are likely to remain directly under a spotlight exposing them to excess heat
- Special glass reflector and additional filtering lenses greatly reduce heat from spotlight onto doors
- Great light output without direct glare
- Overall surface height only 1/16"
- Frosted tempered glass lens
- Easy to relamp
- Includes 12 V/10 or 20 W 4,000 hr. Osram bulb
- Attached 6" connecting cable with NV6 plug
- Available in white, black, chrome and gold
- 1.5 clearance on backside of fixture is necessary

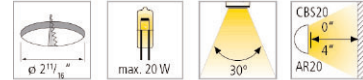
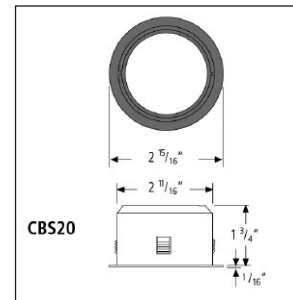

MODEL NO	COLOR	LAMPS		DIMENSIONS	
		QTY	HALOGEN	D	DIA
CBS20WH	WHITE	1	20W	1-13/16"	2-15/16"
CBS20BL	BLACK	1	20W	1-13/16"	2-15/16"
CBS20CH	CHROME	1	20W	1-13/16"	2-15/16"
CBS20GO	GOLD	1	20W	1-13/16"	2-15/16"
POWER SUPPLY	DESCRIPTION				
UC-60FT	60 W PREMIUM ELECTRONIC TRANSFORMER, 6' CORD-N-PLUG (CONNECT UP TO 3 LIGHTS)				
UE-E60FT*	60 W ECOLINE ELECTRONIC TRANSFORMER, 6' CORD-N-PLUG (CONNECT UP TO 3 LIGHTS)				
UK-120TW	120 W PREMIUM ELECTRONIC TRANSFORMER (CONNECT UP TO 6 LIGHTS)				
HT-150**	(3) - 60 W OUTPUTS, CLASS II TRANSFORMER, REMOTE MOUNT, HARDWIRE ONLY				
HT-300**	(6) - 60 W OUTPUTS, CLASS II TRANSFORMER, REMOTE MOUNT, HARDWIRE ONLY				

* Previously American Fluorescent part # HT-60

**Item is only supplied as American Fluorescent brand

Halogen-ER1/ES1 Series



Economically Priced Recessed Or Surface Mounted Halogen Spotlight

Accent lighting for vanities, displays, furniture, kitchen cabinets or boats.



Product-Features

- Recess depth only 5/8" or 1/2" (with spacer ring DR1)
- Aluminum reflector
- Screw on decor-ring
- Friction fit, Easy to relamp
- 12 V/10 or 20 W bulb included
- Attached 79" connecting cable with NV6 plug
- Available in white, black, chrome, stainless steel and gold
- Available in complete kits of 2, 3 or 5 lights. See page 41
- Accessories available. See page 48

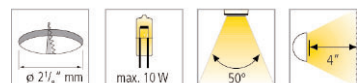
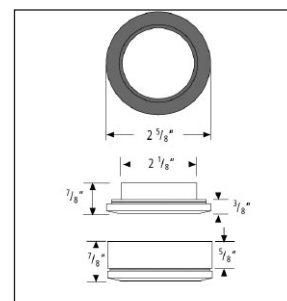

MODEL NO	COLOR	LAMPS	DIMENSIONS	
RECESS	SURFACE	QTY	HALOGEN	D DIA
ER110WH	ES110WH	1	10W	7/8" 2-5/8"
ER110BL	ES110BL	1	10W	7/8" 2-5/8"
ER110CH	ES110CH	1	10W	7/8" 2-5/8"
ER110GO	ES110GO	1	10W	7/8" 2-5/8"
ER110SS	ES110SS	1	10W	7/8" 2-5/8"
ER120WH	ES120WH*	1	20W	7/8" 2-5/8"
ER120BL	ES120BL*	1	20W	7/8" 2-5/8"
ER120CH	ES120CH*	1	20W	7/8" 2-5/8"
ER120GO	ES120GO*	1	20W	7/8" 2-5/8"
ER120SS	ES120SS*	1	20W	7/8" 2-5/8"
POWER SUPPLY	DESCRIPTION			
UC-60FT	60 W PREMIUM ELECTRONIC TRANSFORMER, 6' CORD-N-PLUG (CONNECT UP TO 3 LIGHTS)			
UE-E60FT**	60 W ECOLINE ELECTRONIC TRANSFORMER, 6' CORD-N-PLUG (CONNECT UP TO 3 LIGHTS)			
UK-120TW	120 W PREMIUM ELECTRONIC TRANSFORMER (CONNECT UP TO 6 LIGHTS)			
HT-150***	(3) - 60 W OUTPUTS, CLASS II TRANSFORMER, REMOTE MOUNT, HARDWIRE ONLY			
HT-300***	(6) - 60 W OUTPUTS, CLASS II TRANSFORMER, REMOTE MOUNT, HARDWIRE ONLY			

* Previously American Fluorescent HP1 series

** Previously American Fluorescent part # HT-60

*** Item is only supplied as American Fluorescent brand

ES1 Ecoline Sets



ES1 Sets

These low voltage sets consist of halogen spotlights (for recessed or surface mounting), UC-60FT or UK-120TW (5 light sets) transformers, connecting cables and all hardware to make the installation easy.

Product-Features

- Available in white, black, chrome, gold and stainless steel
- The sets are packaged in an attractive carton suitable for display
- Available in 2, 3 or 5 light sets



MODEL NO	COLOR	LAMPS		DIMENSIONS	
		QTY	HALOGEN	D	DIA
2 LIGHT SET					
C/SET1ES110WH	WHITE	1	10W	1-3/4"	2-5/8"
C/SET1ES110BL	BLACK	1	10W	1-3/4"	2-5/8"
C/SET1ES110CH	CHROME	1	10W	1-3/4"	2-5/8"
C/SET1ES110GO	GOLD	1	10W	1-3/4"	2-5/8"
C/SET1ES110SS	STAINLESS	1	10W	1-3/4"	2-5/8"
2 LIGHT SET					
C/SET1ES120WH*	WHITE	1	20W	1-3/4"	2-5/8"
C/SET1ES120BL*	BLACK	1	20W	1-3/4"	2-5/8"
C/SET1ES120CH*	CHROME	1	20W	1-3/4"	2-5/8"
C/SET1ES120GO*	GOLD	1	20W	1-3/4"	2-5/8"
C/SET1ES120SS*	STAINLESS	1	20W	1-3/4"	2-5/8"
3 LIGHT SET					
C/SET2ES110WH	WHITE	1	10W	1-3/4"	2-5/8"
C/SET2ES110BL	BLACK	1	10W	1-3/4"	2-5/8"
C/SET2ES110CH	CHROME	1	10W	1-3/4"	2-5/8"
C/SET2ES110GO	GOLD	1	10W	1-3/4"	2-5/8"
C/SET2ES110SS	STAINLESS	1	10W	1-3/4"	2-5/8"
3 LIGHT SET					
C/SET2ES120WH	WHITE	1	20W	1-3/4"	2-5/8"
C/SET2ES120BL	BLACK	1	20W	1-3/4"	2-5/8"
C/SET2ES120CH	CHROME	1	20W	1-3/4"	2-5/8"
C/SET2ES120GO	GOLD	1	20W	1-3/4"	2-5/8"
C/SET2ES120SS	STAINLESS	1	20W	1-3/4"	2-5/8"
5 LIGHT SET					
C/SET3ES120WH	WHITE	1	20W	1-3/4"	2-5/8"
C/SET3ES120BL	BLACK	1	20W	1-3/4"	2-5/8"
C/SET3ES120CH	CHROME	1	20W	1-3/4"	2-5/8"
C/SET3ES120GO	GOLD	1	20W	1-3/4"	2-5/8"
C/SET3ES120SS	STAINLESS	1	20W	1-3/4"	2-5/8"
POWER SUPPLY INCLUDED					

Halogen/Xenon-Transformer

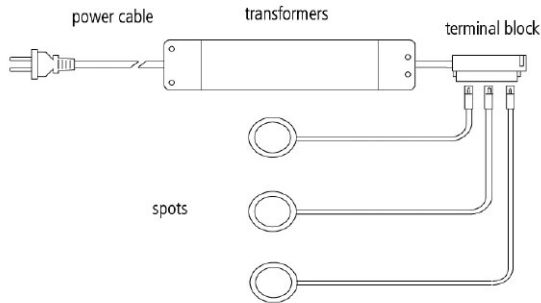

Ultra-Slim Electronic Premium Transformer

Its height of only 1/2" makes this transformer the preferred choice for even the tightest areas. This high-end transformer features an integrated radio frequency interference suppressor. It's especially recommended for commercial applications, entertainment centers, etc.

Product-Features

- Ultra-slim, only 1/2" high
- 110 V/11.5V eff, 10-60 VA
- Weight only 3.2 oz
- Short circuit protection
- Overload protection
- Overheat protection
- Soft start for maximum lamp life
- Dimmable with standard dimmers
- Radio frequency interference suppressor
- Voltage compensation circuit
- 79" plug-in power cord
- 10" 12 V connector with NVK6/3 plug-in terminal
- Auto reset technology-no fuses

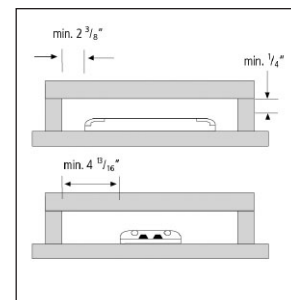
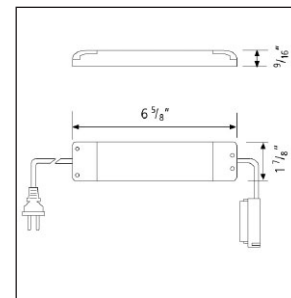

MODEL NO	COLOR	DESCRIPTION
PREMIUM TRANSFORMER		
UC-60FT	WHITE	60 W PREMIUM ELECTRONIC TRANSFORMER, 6' CORD-N-PLUG (CONNECT UP TO 3 LIGHTS)

Halogen/Xenon-Transformer

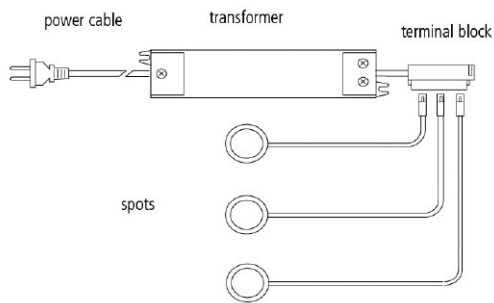

Compact Electronic Ecoline Transformer

New compact economically priced electronic transformer. Uses latest SMD technology. Standard power supply, suitable for all Hera halogen spotlights. Perfect for residential applications.

Product-Features

- 110 V/11.5 V eff, 10-60 VA
- Weight only 3.2 oz
- Short circuit protection
- Overload protection
- Overheat protection
- Soft start for maximum lamp life
- Dimmable with standard dimmers
- Voltage compensation circuit
- 79" plug-in power cord
- 10" 12 V connector with NVK6/3 plug-in terminal
- Auto reset technology-no fuses

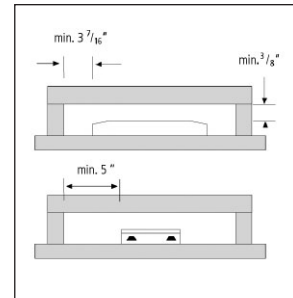
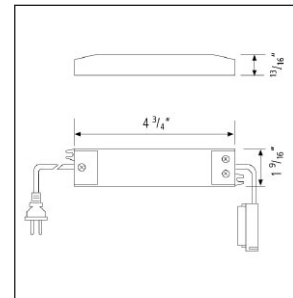

MODEL NO	COLOR	DESCRIPTION
ECOLINE TRANSFORMER		
UE-E60FT*	GREY	60 W ECOLINE ELECTRONIC TRANSFORMER, 6' CORD-N-PLUG (CONNECT UP TO 3 LIGHTS)

* Previously American Fluorescent HT-60

Halogen/Xenon-Transformer

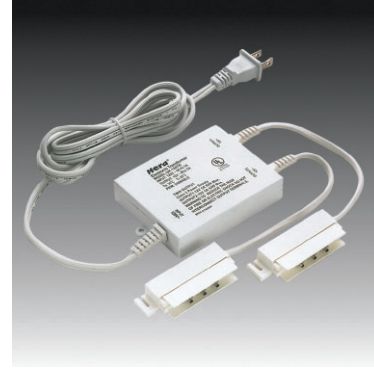
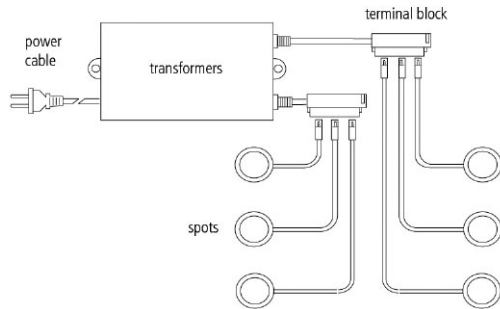

Ultra-Slim Electronic Premium Transformer

Finally, a 120 VA transformer which meets UL's strictest class II requirements. This high-end transformer features an integrated radio frequency interference suppressor which makes it perfect for commercial and residential applications.

Product-Features - UK-120TW

- Very compact dimensions
- 110 V/11.5 V eff, 20-120 VA
- Weight only 4.8 oz
- Short circuit protection
- Overload protection
- Overheat protection
- Soft start for maximum life lamp
- Dimmable with standard dimmers
- Radio frequency interference suppressor
- Voltage compensation circuit
- 79" plug-in power cord
- 2 x 10" 12 V connector with NVK6/3 plug-in terminal
- Auto reset technology-no fuses

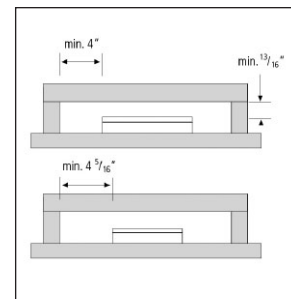
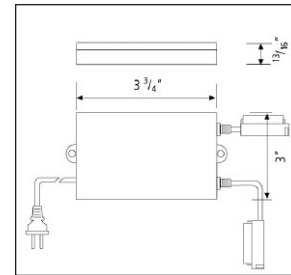

Product-Features - HT-150/HT-300

- 120 V / 11.7 V eff
- Class II outputs
- Short circuit protection
- Overload protection
- Auto reset
- Dimmable
- Aluminum inner casing
- Steel outer casing



MODEL NO	COLOR	DESCRIPTION
TRANSFORMER		
UK-120TW	WHITE	120 W PREMIUM ELECTRONIC TRANSFORMER (CONNECT UP TO 6 LIGHTS)
HT-150*		(3) - 60 W OUTPUTS, CLASS II TRANSFORMER, REMOTE MOUNT, HARDWIRE ONLY
HT-300*		(6) - 60 W OUTPUTS, CLASS II TRANSFORMER, REMOTE MOUNT, HARDWIRE ONLY

* Item is only supplied as American Fluorescent brand

Halogen/Xenon-Touch Dimmer



Touch Dimmer

Four level dimmer. For fingertip control of switching and dimming-just connect the touch control wire to any metallic surface, e.g. cabinet hinge, metal screw, metal knob, etc. or use the touch pad version when a metal surface is not available.

Product-Features

ETD1

- 110 V/60Hz maximum 300 W
- Can be used with 1-5 60 W or 1-2 120 W electronic transformers
- Provides 4 level linear dimming: off, 50%, 75%, 100%
- Easy installation-no wiring necessary
- 3' touch wire with U-ring
- Comes pre-wired with 10' power cord and 12" (3) outlet end

ETD1/TP

- Same as above, but with touch pad

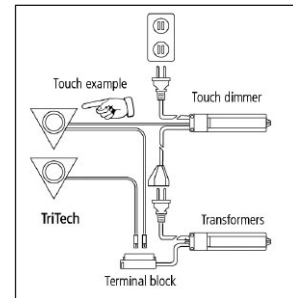

MODEL NO	COLOR	DESCRIPTION
ETD1	BLACK	110 V/60 HZ MAX 300 W (FOR USE WITH METAL SURFACE)
ETD1/TP	BLACK	110 V/60 HZ MAX 300 W TOUCH PAD (NO METAL SURFACE)

Halogen/Xenon-Rotary Dimmer



Rotary Dimmer

Full range dimmer for all Hera halogen systems.

Product-Features

- 110 V/60 Hz maximum 300 W
- Can be used with 1-5 60 W or 1-2 120 W electronic transformers
- Provides linear dimming from 0-100%
- Easy installation-no wiring necessary
- Available in black or white
- Surface mount on to top or bottom of board
- Pre-wired with 10' power cord and 12" (3) outlet end

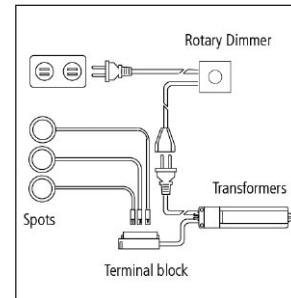

MODEL NO	COLOR	DESCRIPTION
ROTARY DIMMER		
ERD1WH	WHITE	110 V/60 HZ MAX 300 W
ERD1BL	BLACK	110 V/60 HZ MAX 300 W

Halogen/Xenon-Accessories

MODEL NO	PREMIUM LINE HALOGEN	
DISTANCE RING	COLOR	DESCRIPTION
S12WH	WHITE	USE TO SURFACE MOUNT KB12 HALOGEN SPOTLIGHTS
S12BL	BLACK	USE TO SURFACE MOUNT KB12 HALOGEN SPOTLIGHTS
S12CH	CHROME	USE TO SURFACE MOUNT KB12 HALOGEN SPOTLIGHTS
S12GO	GOLD	USE TO SURFACE MOUNT KB12 HALOGEN SPOTLIGHTS
S12SS	STAINLESS	USE TO SURFACE MOUNT KB12 HALOGEN SPOTLIGHTS
DECOR RING		
DR12WH	WHITE	COVER RING FOR KB12 HALOGEN SPOTLIGHTS
DR12BL	BLACK	COVER RING FOR KB12 HALOGEN SPOTLIGHTS
DR12CH	CHROME	COVER RING FOR KB12 HALOGEN SPOTLIGHTS
DR12GO	GOLD	COVER RING FOR KB12 HALOGEN SPOTLIGHTS
DR12SS	STAINLESS	COVER RING FOR KB12 HALOGEN SPOTLIGHTS
SPACER RING R12		
R12WH	WHITE	REDUCE RECESS DEPTH FOR KB12 HALOGEN SPOTLIGHTS
R12BL	BLACK	REDUCE RECESS DEPTH FOR KB12 HALOGEN SPOTLIGHTS
R12CH	CHROME	REDUCE RECESS DEPTH FOR KB12 HALOGEN SPOTLIGHTS
R12GO	GOLD	REDUCE RECESS DEPTH FOR KB12 HALOGEN SPOTLIGHTS
R12SS	STAINLESS	REDUCE RECESS DEPTH FOR KB12 HALOGEN SPOTLIGHTS
SPACER RING DR13		
DR13WH	WHITE	REDUCE RECESS DEPTH FOR ARF HALOGEN SPOTLIGHTS
DR13BL	BLACK	REDUCE RECESS DEPTH FOR ARF HALOGEN SPOTLIGHTS
DR13CH	CHROME	REDUCE RECESS DEPTH FOR ARF HALOGEN SPOTLIGHTS
DR13GO	GOLD	REDUCE RECESS DEPTH FOR ARF HALOGEN SPOTLIGHTS
DR13SS	STAINLESS	REDUCE RECESS DEPTH FOR ARF HALOGEN SPOTLIGHTS
DISTANCE RING		
DI13WH	WHITE	USE TO SURFACE MOUNT ARF HALOGEN/LED SPOTLIGHTS
DI13BL	BLACK	USE TO SURFACE MOUNT ARF HALOGEN/LED SPOTLIGHTS
DI13CH	CHROME	USE TO SURFACE MOUNT ARF HALOGEN/LED SPOTLIGHTS
DI13GO	GOLD	USE TO SURFACE MOUNT ARF HALOGEN/LED SPOTLIGHTS
DI13SS	STAINLESS	USE TO SURFACE MOUNT ARF HALOGEN/LED SPOTLIGHTS
TOP CAP		
K63WH	WHITE	USE TO PLUG TOP OF HOLE THAT HAS BEEN DRILLED THROUGH
GLASS LENSES		
PGLFR	STANDARD	FOR ARF/ARFS20 SERIES
KBGLFR	FROSTED	FOR KB/KBS12 SERIES
GL2CL	CLEAR	FOR ARCTECH AL SERIES
GLSHFR	FROSTED	GLASS SHADE FOR BL1/A SERIES

MODEL NO	ECOLINE HALOGEN	
DISTANCE RING	COLOR	DESCRIPTION
EDIWH	WHITE	USE TO SURFACE MOUNT ER1 HALOGEN SPOTLIGHTS
EDIBL	BLACK	USE TO SURFACE MOUNT ER1 HALOGEN SPOTLIGHTS
EDICH	CHROME	USE TO SURFACE MOUNT ER1 HALOGEN SPOTLIGHTS
EDIGO	GOLD	USE TO SURFACE MOUNT ER1 HALOGEN SPOTLIGHTS
EDISS	STAINLESS	USE TO SURFACE MOUNT ER1 HALOGEN SPOTLIGHTS
DECOR RING		
EDRWH	WHITE	COVER RING FOR ES1/ER1 HALOGEN SPOTLIGHTS
EDRBL	BLACK	COVER RING FOR ES1/ER1 HALOGEN SPOTLIGHTS
EDRCH	CHROME	COVER RING FOR ES1/ER1 HALOGEN SPOTLIGHTS
EDRGO	GOLD	COVER RING FOR ES1/ER1 HALOGEN SPOTLIGHTS
EDRSS	STAINLESS	COVER RING FOR ES1/ER1 HALOGEN SPOTLIGHTS
GLASS LENSES		
EGLFR	FROSTED	FOR ES1/ER1 HALOGEN SERIES
SPRING CLIP		
ESPCL		SPRING CLIP FOR ER1

Halogen/Xenon-Accessories

MODEL NO	PREMIUM LINE XENON	
DISTANCE RING	COLOR	DESCRIPTION
X-DIWH	WHITE	USE TO SURFACE MOUNT XR1 XENON SPOTLIGHTS
X-DIBL	BLACK	USE TO SURFACE MOUNT XR1 XENON SPOTLIGHTS
X-DICH	CHROME	USE TO SURFACE MOUNT XR1 XENON SPOTLIGHTS
X-DIGO	GOLD	USE TO SURFACE MOUNT XR1 XENON SPOTLIGHTS
X-DISS	STAINLESS	USE TO SURFACE MOUNT XR1 XENON SPOTLIGHTS
DECOR RING		
X-DRWH	WHITE	USE TO SURFACE MOUNT XR/XS1 XENON SPOTLIGHTS
X-DRBL	BLACK	USE TO SURFACE MOUNT XR/XS1 XENON SPOTLIGHTS
X-DRCH	CHROME	USE TO SURFACE MOUNT XR/XS1 XENON SPOTLIGHTS
X-DRGO	GOLD	USE TO SURFACE MOUNT XR/XS1 XENON SPOTLIGHTS
X-DRSS	STAINLESS	USE TO SURFACE MOUNT XR/XS1 XENON SPOTLIGHTS
GLASS LENSES		
X-GLFR	FROSTED	FOR XR/XS1 XENON SERIES

MODEL NO	ADDITIONAL ACCESSORIES	
CABLES	COLOR	DESCRIPTION
2NV6500		20" LONG CONNECTING CABLE FOR HALOGEN & XENON SPOTLIGHTS
2NV61000		39" LONG CONNECTING CABLE FOR HALOGEN & XENON SPOTLIGHTS
2NV62000		79" LONG CONNECTING CABLE FOR HALOGEN & XENON SPOTLIGHTS
2NV63000		120" LONG CONNECTING CABLE FOR HALOGEN & XENON SPOTLIGHTS
TERMINAL BLOCK		
NVK64		FOUR SOCKET TERMINAL BLOCK FOR HALOGEN AND XENON SPOTLIGHTS
SWITCHES		
SAHWH	WHITE	SURFACE MOUNTED
SAHBL	BLACK	SURFACE MOUNTED
SAHCH	CHROME	SURFACE MOUNTED
SAHGO	GOLD	SURFACE MOUNTED
SEHWH	WHITE	RECESS MOUNTED
SEHBL	BLACK	RECESS MOUNTED
SEHCH	CHROME	RECESS MOUNTED
SEHGO	GOLD	RECESS MOUNTED
SRIG1	WHITE	SWITCH -RIG
DCS	WHITE	DOOR CONTACT SWITCH
BULBS		
PB10		10 W PREMIUM HALOGEN BULB
PB20		20 W PREMIUM HALOGEN BULB
EB10		10 W ECONOLINE BULB - G4 SOCKET
EB20		20 W ECONOLINE BULB - G4 SOCKET
BEH24		20 W MR11 BULB FOR EH24
MR1620		20 W MR16 BULB FOR ARCLAMP
MR1635		35 W MR16 BULB FOR ARCLAMP
MR1650		50 W MR16 BULB FOR ARCLAMP
MR16LED		3X 1W MR16-LED BULB FOR ARCLAMP
X-B18W		18 W XENON BULB
X-HB20W		20 W XENON BULB
OTHER		
SAW45		1-3/4" HOLE SAW
SAW55		2-1/8" HOLE SAW
SAW68		2-11/16" HOLE SAW
SAW HOLDER		ARBOR FOR HOLE SAW
DRILL 10		3/8" DRILL BIT

Halogen & Xenon Bulbs

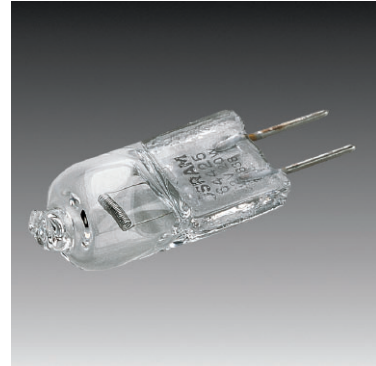

Product-Features

BI-PIN

PB10/PB20

Premium length halogen bulb, 10 or 20 W (12 V), rated 4,000 hrs.

EB10/EB20

Ecoline halogen bulb, 10 or 20 W (12 V), rated 2,000 hrs.

Xenon X-HB20

Can be used with Hera halogen spotlights, 20 W (12 V), rated 10,000 hrs.

Xenon X-B18

Wedge base, 18 W (12 V) for XR1 /XS1, rated 8,000 hrs.

BEH24, MR 11 bulb

Lensed halogen bulb, 20 W (12 V) for EH, rated 3,000 hrs.

MR16 bulbs

Lensed halogen bulb, 20, 35 and 50 W for Hera Arclamps, rated 3,000 hrs.

MR16 bulbs

3 x 1 W LED bulb, rated 50,000 hrs.



Product Highlights

Product quality and leading edge features are very important to American Fluorescent. Hera products provide the benefits and features to meet and exceed customer expectations. Hera's mission is the design, development, and manufacture of quality lighting systems. When considering which system is right for your application compare other solutions to our specifications.

Transformers

- Voltage compensation circuit:
Prevents premature bulb failure
- Auto-reset technology:
Electronic circuitry operates "without" fuses and resets itself with overheat, short-circuit, or overload is fixed
- Overheat protection
- Short circuit protection
- Terminal block is an integral part of the transformer:
This makes the connecting system easy and almost foolproof

Spotlights

- Can be recessed into a pocket hole without any ventilation on the back surface
- Aluminum reflectors:
Cause high light output
- Air ventilation system:
Allows for better heat dissipation and low temperatures at surface
- Special heat resistant plastic
- Plastic flange behind reflector:
Insulates surface from reflector reducing surface heat
- Upgraded lamp socket:
Specially designed to handle high temperatures which eliminates future problems with relamping
- Frosted lens available:
Some systems cannot get a UL listing with frosted lens due to heat problems. This allows for better light distribution and less glare
- German plating:
Insures high quality plating which will not flake or bubble

Installation Options

Recessed In Pocket Hole

One of the unique features of Hera halogen spotlights is UL listing for "pocket hole" installation. This means that you do not have to drill all the way through the board when recessing Hera halogen spotlights. In 3/4" boards you simply drill 5/8" into the board (No additional ventilation is needed).



Semi Recessed (Requires Spacer Ring)

In 5/8" boards Hera halogen spots can still be recessed into a pocket hole using a spacer ring. The spacer ring reduces the recess depth to 1/2".

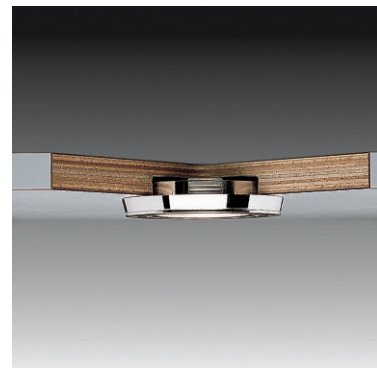

Surface Mounted

Hera halogen spots can also be surface mounted without drilling into the board at all.



Mounting Examples

New Construction New Kitchen With Access To Power On Top

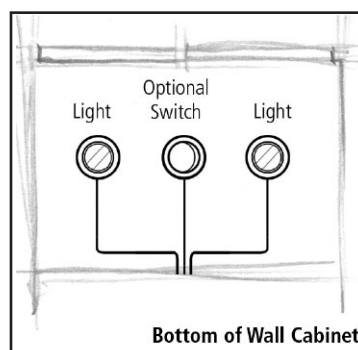
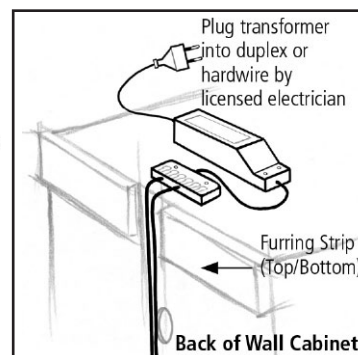
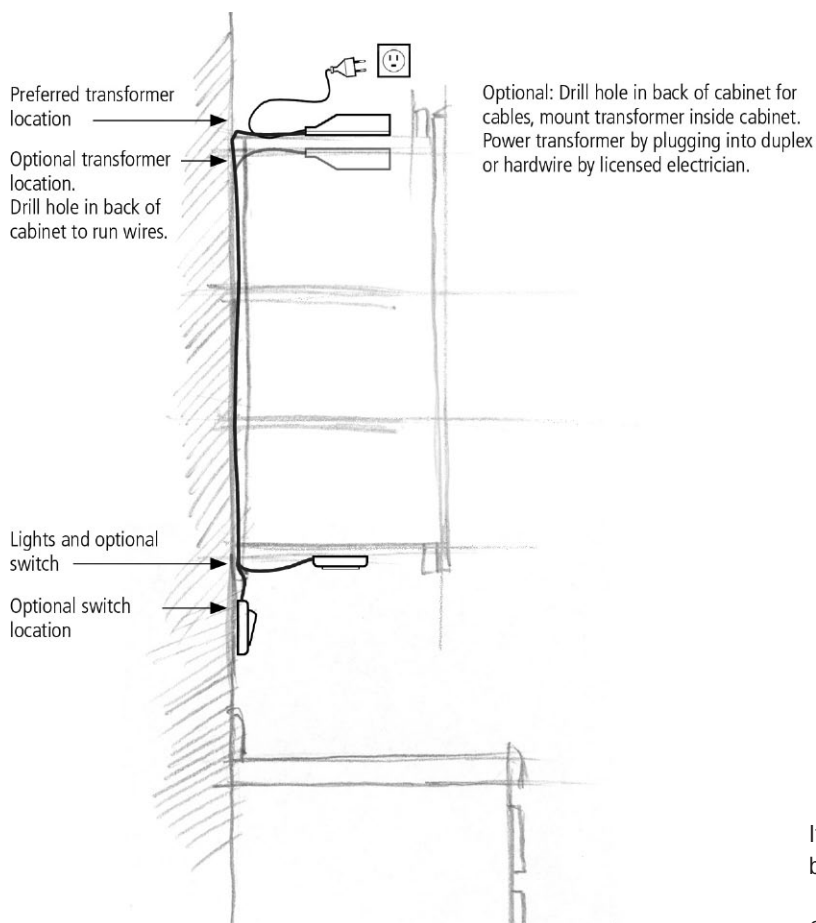

Note: If you have a switchable outlet above or beneath the cabinet, plug directly to the outlet. Dimmer may be used. If you do not have a switchable outlet, use the switch and switch-rig, or the touch or rotary dimmer.

If using optional switch, mount switch on bottom of cabinet or wall.

Option: Use switch and switch ringset if switchable outlet is not available.

Use optional wire management to conceal cable on bottom. Custom fit if necessary.

Mounting Examples

Retrofit Power Above Cabinets

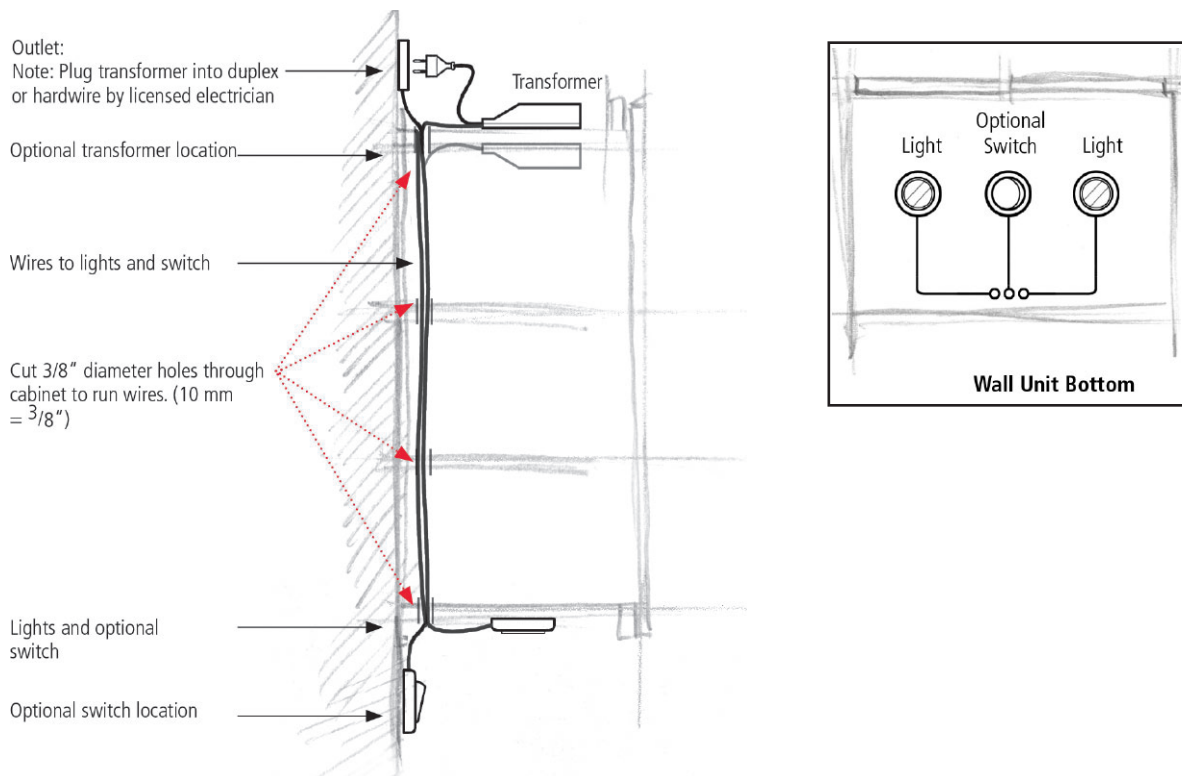

Drill holes (10 mm each/ 3/8") through bottom shelves to run cables.

Use optional wire management to conceal cable on bottom. Custom fit if necessary.

Mounting Examples

Retrofit Application with Power On Bottom

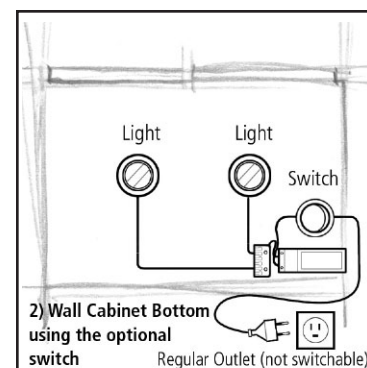
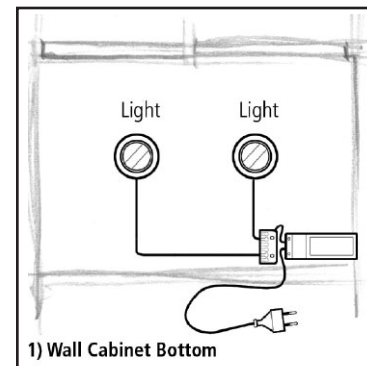
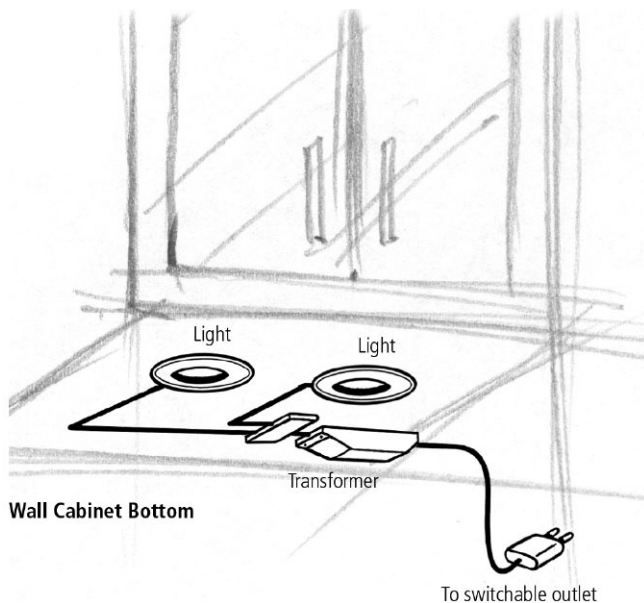

1) Note:
Plug transformer into switched outlet or hardwire by licensed electrician.

2) Note:
Electrician to connect switch as in line switch. Plug transformer into duplex.

Use optional wire management to conceal cable on bottom. Custom fit if necessary.

LED Photometrics

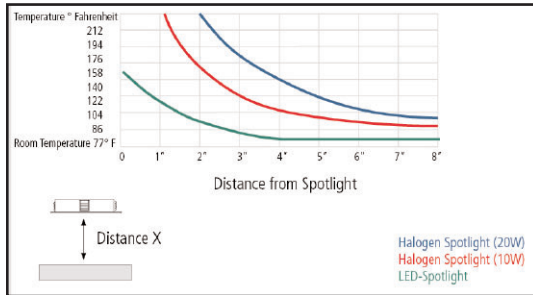

ARF-LED

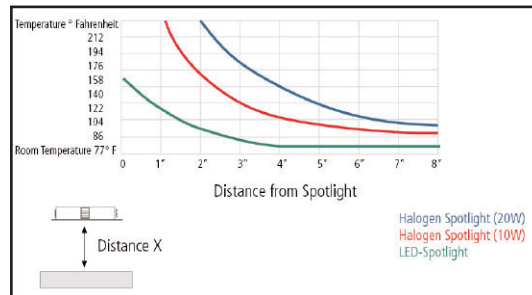

EH24-LED

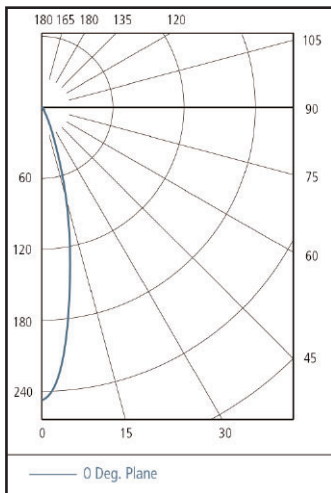

HO-LED1/WW

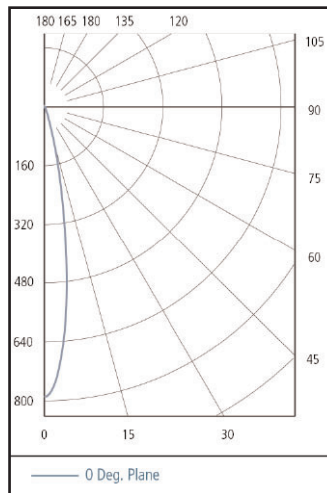

HO-LED2/CW

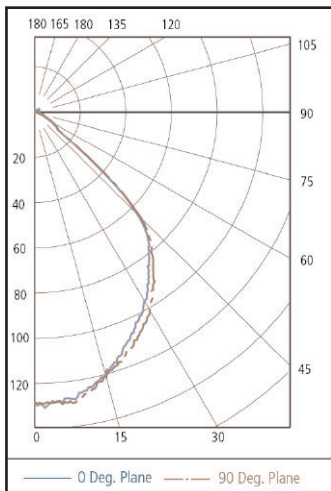

LUMIMAX 13/CW

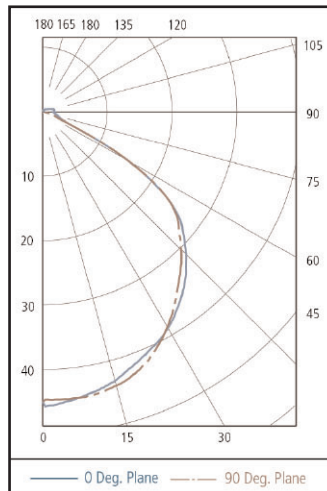

LUMIMAX13/WW

LED Photometrics

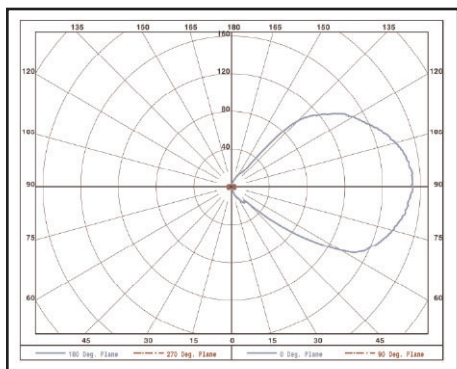

TOWER-LED/WW

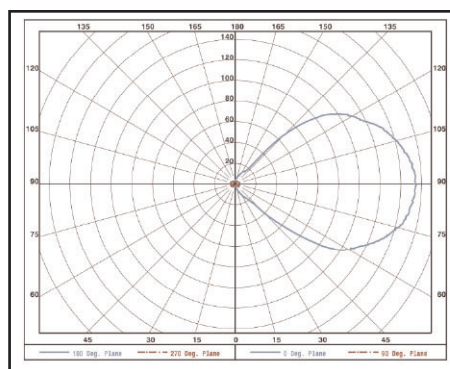

TOWER-LED/CW

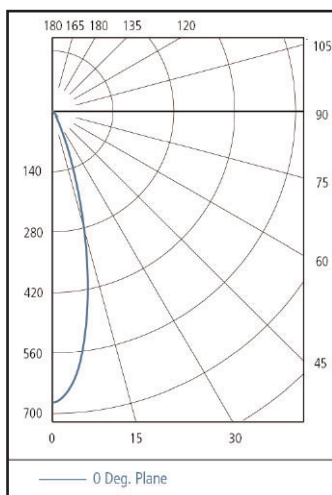

BIG6/LED/CW

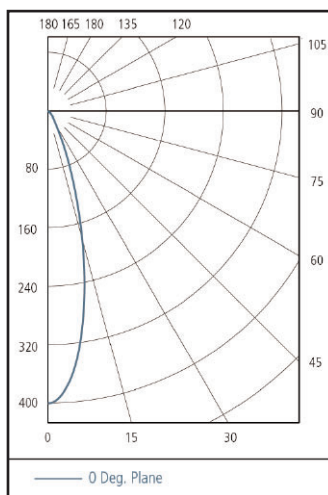

LEDCAN6/WW

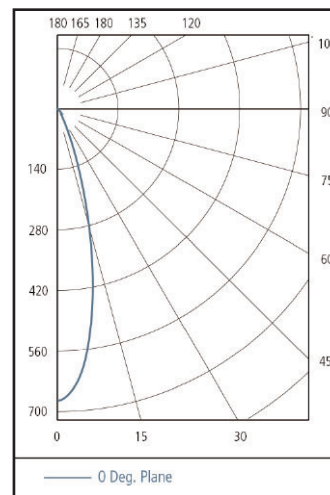

LEDCAN6/CW

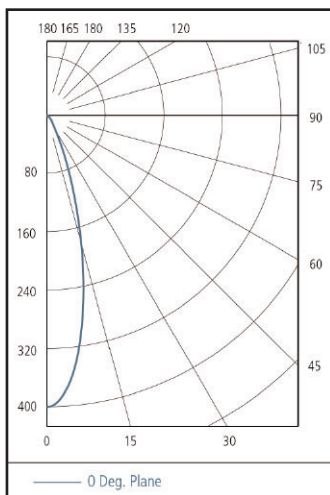

BIG6/LED/WW

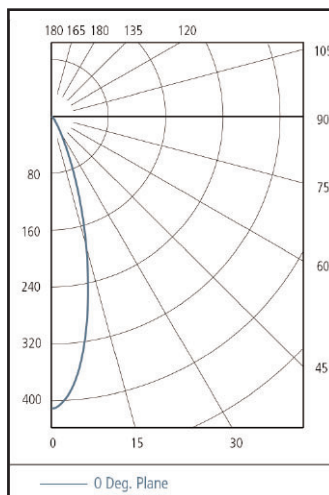

LEDCAN6/PL/WW

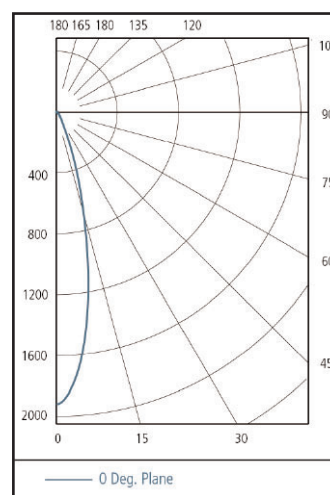

LEDCAN6/PL/CW

Applications



Slimlite



SlimliteXL



HighLite



AH11



KB12



ARF



CAN-LED



EH24



ARCLAMP



CAT# AF/HERA08

2345 N. Ernie Krueger Circle
Waukegan, IL. 60087
PH: 847-249-5970
FX: 847-249-2618
E-mail: info@afcolite.com
www.americanfluorescent.com

